



LAGOON 450

User's guide



www.cata-lagoon.com

WELCOME ABOARD

We share a common passion for the sea; we, LAGOON, as catamaran builders and you who want to live your passion on the seven seas.

We are delighted to welcome you to the family of LAGOON catamaran owners and we congratulate you on it.

This instruction guide is intended to help you to enjoy your boat in comfort and safety. It includes the boat specifications, the equipment provided or installed, the systems on board and tips on her use and maintenance.

We advise you to read this guide carefully before setting sail in order to take the greatest advantage of your sailing.

Our network of LAGOON official retailers is entirely at your disposal in order to help you discovering your boat. They will be the most able to do the maintenance on your boat.



PREAMBULE

- This user guide is a tool that will enable you to get to know your boat and apprehend the use of the components that are necessary for running her.
- A WAY TO MAKE THE MOST OF THIS USER GUIDE

In order to have an easier apprehension, this guide offers you two complementary reading levels:

- . The pages with text on the right hand side of the document develop the different subjects dealt with in the chapters,
- . The pages on the left hand side are given to the related photos, layouts or block diagrams.

- The different warnings used throughout this guide are as follows:

RECOMMENDATION

Shows a piece of advice to do the appropriate actions or manoeuvres adapted to what you are thinking of doing.

WARNING

Draws your attention on dangerous ways of doing that may bring about injuries to people or damages to the boat or her components.

DANGER

Warns you about the existence of a hazard that may have serious or fatal consequences if the appropriate precautions are not taken.

- Before you put out to sea, please read the owner's manual (CE standard manual) delivered with your boat and please follow the instructions.
-

CONTENTS

1. SPECIFICATIONS PAGE 7	5. UTILITY ABOARD..... PAGE 47	8. MOTORIZATION..... PAGE 83
1.1 I D of your boat	5.1 Refrigerators - Conservator - Ice maker	8.1 Engines
1.2 Technical specifications	5.2 Microwave oven	8.2 Fuel
	5.3 Oven, hotplate	8.3 Propellers - Anodes
	5.4 Dishwasher	8.4 Dash board
	5.5 Washer dryer	8.5 Optional controls
	5.6 Television	
	5.7 Air conditioning system	
	5.8 Heating system	
2. HULL / DECK PAGE 13	6. WATER SYSTEMS PAGE 57	9. WINTER STORAGE..... PAGE 91
2.1 Construction	6.1 Bilge pump system	9.1 Laying up
2.2 Careening	6.2 Grey waters	9.2 Protection
2.3 Deck equipment	6.3 Black waters	
2.4 Cockpit	6.4 Fresh water	
2.5 Access to fly helm station	6.5 Watermaker	
2.6 Steering system		
2.7 Anchoring		
2.8 Deckwash pump		
2.9 Gangway		
2.10 Davits		
3. RIGGING / SAILS PAGE 27	7. ELECTRICITY PAGE 69	10. HANDLING PAGE 95
3.1 Sailing	7.1 12 V circuit	10.1 Preparation
3.2 Standing rigging	7.2 Inverters	10.2 Crane lifting
3.3 Running rigging	7.3 110 V - 220 V circuits	10.3 Mast stepping and removal
3.4 Sails	7.4 Electronics	
4. ACCOMMODATIONS..... PAGE 41		11. SAFETY PAGE 99
4.1 Saloon - Galley		11.1 Prevention
4.2 Lighting		11.2 Gas system
4.3 Portholes - Deck hatches		11.3 Fire
4.4 Window blinds		11.4 Bilge pump system
		11.5 Safety equipments
		11.6 General remarks
		12. MAINTENANCE..... 111
		12.1 Maintenance schedule

SPECIFICATIONS

1

1.1 I D of your boat

1.2 Technical specifications

YOUR BOAT

NAME OF YOUR BOAT:	OWNER'S NAME:
VERSION:	ADDRESS:
DELIVERY DATE:
HULL NUMBER:
MAKE OF THE ENGINES:	E-MAIL ADDRESS:
NUMBERS OF THE ENGINE KEYS:	LANDLINE PHONE NUMBER:
STARBOARD ENGINE SERIAL NUMBER:	MOBILE PHONE NUMBER:
PORT ENGINE SERIAL NUMBER:	
FURTHER INFORMATION:	
.....	
.....	
.....	
.....	
.....	
.....	

EMERGENCY CONTACT

1



www.cata-lagoon.com

162, quai de Brazza - 33100 Bordeaux - France • Tel. 33 (0) 557 80 92 80 • Fax 33 (0) 557 80 92 81 • E-mail: info@cata-lagoon.com

DESIGN CATEGORIES

CATEGORY A

The boat is designed for sailing in winds that may exceed force 8 on the Beaufort Scale and in waves of a significant height of 4 m and more and the boat is to a large extent self-sufficient.

Unusual conditions such as hurricanes are excluded.

You may meet with such conditions when you sail long crossings, for instance across the oceans, or close to the shore when you are not protected from the wind or waves over several hundreds of nautical miles.

CATEGORY B

The boat is designed for sailing in winds that may exceed force 8 on the Beaufort Scale and in waves of a significant height of 4 m and more and the boat is to a large extent self-sufficient.

You may meet with such conditions when sailing at open sea, or close to the shore when you are not protected from the winds and waves over several hundreds of nautical miles. You may also meet with such conditions when sailing quite important inland seas which could produce waves of this height.

CATEGORY C

The boat is designed for sailing in winds that do not exceed force 6 on the Beaufort Scale and in the corresponding waves (waves of a significant height inferior or equal to 2 m).

You may meet with such conditions in exposed inland waters, in estuaries and in coastal waters with mild weather conditions.

CATEGORY D

The boat is designed for sailing in winds that do not exceed force 4 on the Beaufort Scale and in the corresponding waves (occasional 0.5 m high waves at a maximum).

You may meet with such conditions in sheltered inland waters and in coastal waters in fine weather.

NOTE:

The significant height of a wave is the average height of the upper third of the waves; this corresponds more or less to the height of a wave an experienced observer can assess.

Some waves will be twice as high as this value.

TECHNICAL SPECIFICATIONS

Length Over All.....	13.96 m / 45'10"
Waterline length.....	13.38 m / 43'11"
Beam.....	7.84 m / 25'9"
Air draft.....	23.05 m / 75'62"
Keel draft.....	1,30 m / 4'28"
Light displacement.....	16900 kg / 37265 lbs
Full load displacement (cat. A).....	22015 kg / 48543 lbs
Full load displacement (cat. B).....	22150 kg / 48841 lbs
Full load displacement (cat. C).....	22520 kg / 49657 lbs
Full load displacement (cat. D).....	23350 kg / 51487 lbs
Maximum load (cat. A).....	5115 kg / 11279 lbs
Maximum load (cat. B).....	5120 kg / 11290 lbs
Maximum load (cat. C).....	5620 kg / 12392 lbs
Maximum load (cat. D).....	6410 kg / 14134 lbs

Water capacity.....	2 x 175 l + 2 x 175 l (option) / 2x46 US gal
Fuel oil capacity.....	2 x 500 l / 2x132 US gal
Refrigeration unit capacity ..	130 l + 130 l (optional) + 80 l (optional)
.....	34 US gal + 34 US gal (optional) + 21 US gal (optional)

BATTERY CAPACITY

Standard.....	3 x 140 Ah (12 V)
Optional.....	3 x 140 Ah (12 V)
Engines.....	2 x 110 Ah (12 V)
Generator.....	110 Ah (12 V)
Engine power.....	2 x 40 HP

CE CATEGORY	Maximum number of persons
A.....	12 persons
B.....	14 persons
C.....	20 persons
D.....	30 persons

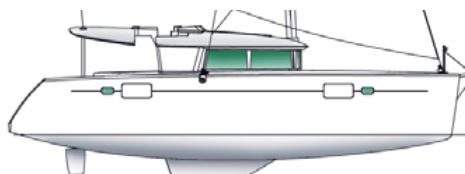

Bottom surface: approx. 58 m² / 624 sq ft

1

SPECIFICATIONS

HULL / DECK

2

- 2.1 Construction**
- 2.2 Careening**
- 2.3 Deck equipment**
- 2.4 Cockpit**
- 2.5 Access to fly helm station**
- 2.6 Steering system**
- 2.7 Anchoring**
- 2.8 Deckwash pump**
- 2.9 Gangway**
- 2.10 Davits**

■ 2.1 Construction

The LAGOON 450 is constructed following the infusion process of a polyester resin and a high quality anti-osmotic resin on a core of balsa and fibreglass layers.

The hull bottoms and keels are made of monolithic laminates by infusion.

WARNING

Do not let the hull's large plexiglass windscreens come into contact with fenders or hawsers: surface damage would be irreparable.

■ 2.2 Careening

A periodical careening of your boat will keep her original performances and avoid any adhesion of marine vegetation.

The type of the water where you boat sails determines how to choose the antifouling paint as well as how often to carry out these careenings.

Please contact a professional for advice.

■ 2.3 Deck equipment

• DECK FITTINGS

The fittings on the deck of your LAGOON 450 were selected according to quality criteria.

To keep them to their best look, a regular maintenance is necessary.

- Rinse the equipments with fresh water, particularly the stainless steel parts.
- Lubricate the different blocks, sheaves, turnbuckles, winches, tracks and travellers.
- Clean and polish the stainless steel parts with a chrome and stainless steel polish in case of oxidation.

• PULPITS

Regularly rinse the stainless steel parts with fresh water.

• LIFELINES

Inspect the metal lifelines for 'hairy wires'.

Check for corrosion, in particular on the connections.

• OUTSIDE WOODWORK

Regularly rinse and brush the outside woodwork with fresh water.

There are teak cleaners and brighteners on sale.

The use of a pressure washer is not advisable on teak.

DECK EQUIPMENT

**ENTRANCE DOOR
LOCKING SYSTEM**



**COCKPIT TABLE
STORAGE SPACE**



**OPENING SERVING
HATCH**



HULL / DECK

BIN LOCKER



SHOWER IN TRANSOM



SUNROOF



LAGOON 450

- PLEXIGLAS

To protect the surface of your windows in plexiglas, avoid any contact with alcohols, tanning creams, sand and all abrasive products generally speaking.

- Rinse the plexiglas with fresh water, do not use solvents.
- Brighten up with a soft rag soaked with a gentle cleaning product.
- Use polish paste to remove scratches.

■ 2.4 Cockpit

- ACCESS DOORS

The sliding door is fitted with a mechanism allowing its locking in an open position. A latch on the door jamb allows its locking from inside the saloon.

RECOMMENDATION

While sailing, block the sliding door locking it.

- COCKPIT TABLE

The cockpit table is removable. It can be stored in the fly bridge roof.

WARNING

Be careful when opening the locker located under the flying bridge roof.

- BIN LOCKER

A bin locker with top opening is located on the saloon port side entrance.

- SERVING HATCH

The cockpit is fitted with an opening serving hatch. While sailing, please lock the serving hatch either in the open or closed position.

- SWIM LADDER

A stainless steel swimming ladder is located on the starboard transom. The boat may optionally be fitted with a second swimming ladder.

WARNING

For safety's sake, always sail with the ladder up and kept in position.

- SHOWER

A shower supplied with hot and cold water is located on the starboard side of the transom.

- SUNROOF

The sunroof, located on the fly bridge roof port side can be opened from the cockpit. It enables you to optimize the cockpit airing and offers a better field of vision when manoeuvring in reverse.

STROP - ELECTRIC WINDLASS

HULL / DECK

18

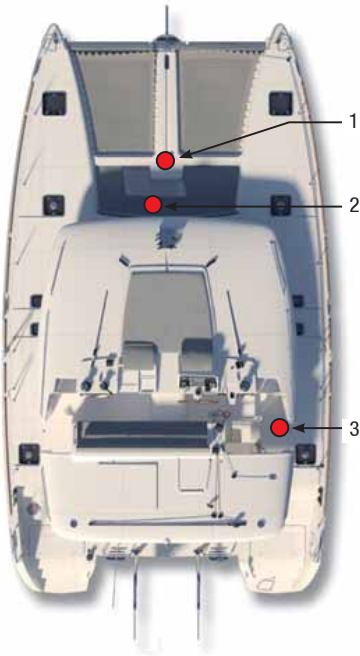

- 1 - Electric windlass.
- 2 - Control of the electric windlass.
- 3 - Windlass automatic breakers.

STROP CIRCUIT



ELECTRIC WINDLASS

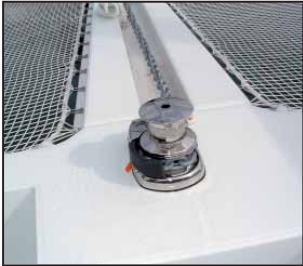

CONTROL OF THE WINDLASS



AUTOMATIC BREAKER OF THE WINDLASS



LAGOON 450

■ 2.5 Access to the fly helm stations

Two stairs, one on the starboard and the other on the port side, lead you from the cockpit to the steering wheel on the flying bridge.

While sailing, pay attention to the possible movements of the boat when using the stairs.

■ 2.6 Steering system

The steering system is made up of steering cables (stainless steel cables) and an aluminium quadrant.

You can reach it through the engine compartments both starboard and port sides.

The suspended rudders are fitted with stainless steel stocks.

Only WD 40 should be used to maintain nylon ertalon or teflon bushings.

Please refer to Chapter 'SAFETY' as for the emergency tiller use.

■ 2.7 Anchoring

• WINDLASS

The electric windlass works with the 12 V domestic batteries. Activate the windlass using its control located in the starboard side locker on the front deck.

If the electrical windlass does not function properly, check its fuse under the aft starboard side cabin berth.

For the maintenance of the windlass, please refer to the manufacturer's guide.

RECOMMENDATION

Use the electric windlass when one or two engines are operating.

• PREPARING ANCHORING

Set the strop fastening it to the chainplates at the ends of the main beam.

Insert the strop inside the stem anchor roller.

Make fast the strop to the central cleat when lowering the chain.

RECOMMENDATION

Before you anchor, check the type of the sea bed, the depth of water and the strength of the stream.

DECKWASH PUMP

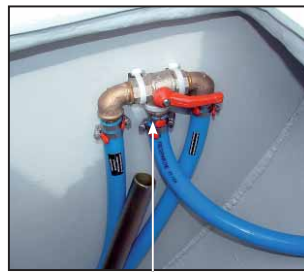
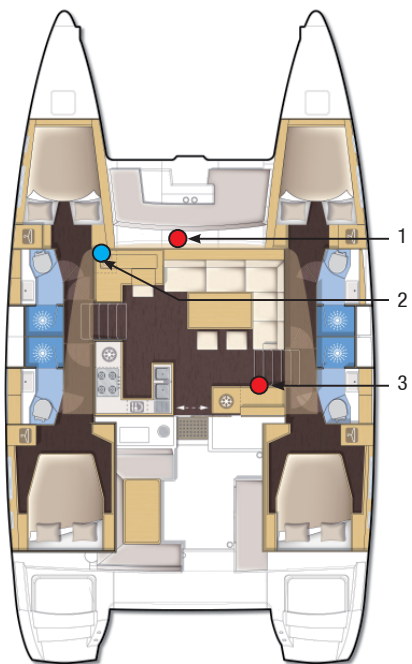

1



2

- 1 - Valve to select fresh water / sea water.
- 2 - Deckwash pump.
- 3 - Power switch.



3

Nota: the same layout can be observed in the other version.

LAGOON 450

• ANCHORING

Have your boat head wind and without speed.
Pay out the chain while moving back slowly.
Secure the chain on the strop.
Release the chain until the strop is taut.
Pay attention to the swinging space when mooring.

• RAISING THE GROUND TACKLE

Check the chain is properly set on the grab.
Operate the windlass setting it to the 'upward' position.
Slowly go near the anchor using the engine (do not use the windlass force to winch up the boat).
Visually check the final metres until the anchor gets into contact with the anchor fairlead.
Check the position of the anchor on the stem fitting.

Rinse the windlass and the ground tackle with fresh water after each trip.

In case of electric failure, use the winch handle on the windlass to raise the ground tackle.

WARNING

Windlass operations are dangerous:

- Always keep the ground tackle clear and free.
- Always proceed with care, wearing gloves and always wearing shoes.
- Make sure that nobody leans on the windlass when operating the control.

Nota: the boat may optionally be fitted with a chain counter and with a windlass control located on the command post.
The standard calibration zero corresponds to the position 'anchor ready to let it go'.

For its use and maintenance please refer to its instruction guide.

■ **2.8 Deckwash pump (optional extra)**

The deck wash pump is located in the cupboard in the port side front cabin.

It can provide fresh or sea water coming from the tanks.
The fresh or sea water selector valve is located in the fore peak port side locker.

Turn on the deck wash pump using its control located in the saloon under the electrical panel.

DAVITS

HULL / DECK

22



- 1 - Davits circuit breaker.
- 2 - Davits electric winch + controls.

DAVITS



DAVITS ELECTRIC
WINCH + CONTROLS



DAVITS CIRCUIT BREAKER



DAVIT
BLOCKER



LAGOON 450

■ 2.9 Gangway (optional extra)

The boat may optionally be fitted with a foldable carbon gangway. Remove, store and stow the gangway when sailing.

WARNING

Do not use the gangway as a diving board.

■ 2.10 Davits (optional extra)

The boat may optionally be fitted with manual winch and davits. An electric winch can be chosen as an option. The winch is automatically turned on when the general cut out on board is set to ON.

If it does not function properly, check its fuse located in the electrical room, in the starboard aft passageway.

WARNING

The davits are designed to support a maximum load of 250 kg and a tender which is maximum 3,80 metres long.

• INSTALLING A TENDER ONTO THE DAVITS

After having taken away everything from the tender and removed the cap:

- Fix the davit rope hooks to the front and rear parts of the tender.
- Lock the jammers located on the davits.
- Take the front part of the tender half way up using the cockpit winch.
- Do the same for the rear part.
- Alternatively lift up the front part then the rear part of the tender until it touches the davits.

• LAUNCHING A TENDER FROM THE DAVITS

Put the water drain plug back into position in the tender.

Make fast the tender.

- Check that the jammers located on the davits are locked.
- Run the davits pennant attached to the rear of the tender around the winch (spin at least three times around it).
- Open the jammer and slack the pennant half-way.
- Lock the jammer.
- Do the same for the front part.
- Let the tender go down alternately front and rear until it touches water.

When sailing, remove the tender engine and store it on board.

Moor the tender considering the sea state and the route.

Put in the tender the security equipment in conformity with the registration country of the boat.

SOLAR PANELS

SOLAR PANELS



HULL / DECK

24

LAGOON 450

WARNING

Nobody should be on board or under the tender during manoeuvres carried out with the davits.
Tie up the tender during manoeuvres.

• SOLAR PANELS (OPTIONAL EXTRA)

The boat may optionally be fitted with solar panels.
The solar panels may fit on the davits (optional extra).

2

RIGGING / SAILS 3

- 3.1 Sailing**
- 3.2 Standing rigging**
- 3.3 Running rigging**
- 3.4 Sails**

RIGHTING MOMENT

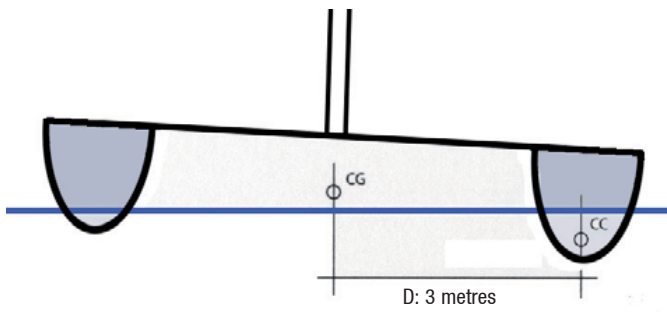

CATAMARAN
Weight of the boat: 10 tons

Illustration of the difference of the righting moment existing between a 10 m monohull and catamaran.

d: distance between centre of the bottom and centre of gravity.

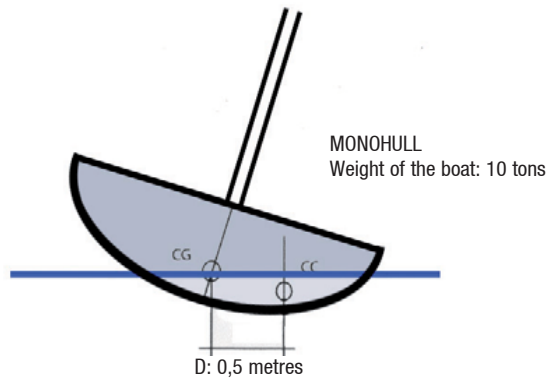

MONOHULL
Weight of the boat: 10 tons

RMmax: Weight of the boat x d
(RMmax: moment of maximum uprighting)

RMmax monohull : 10 tons x 0,5 metres
: 5 tons.metre

RMmax catamaran : 10 tons x 3 metres
: 30 tons.metre

■ 3.1 Sailing

- BEWARE

A catamaran is about 6 times more resistant to heeling than a monohull.

In naval architecture, it is referred to as uprighting moment multiplication of the weight of the boat by the transversal distance between the centre of gravity and the centre of flotation (or bottom). See the illustration on the opposite page.

This fact has real consequences as for the sailing and sail trimming of a catamaran.

The fact that the boat does not heel may mask overcanvassing, which may be very dangerous for the crew and the boat. Therefore you must permanently keep a close eye on the speed of the true wind, and trim the sail surface according to the latter as a matter of priority.

The below-mentioned trims apply in a calm sea. When the sea is brown, you shall reduce earlier by 10% as far as the speed of true wind is concerned. And as a general rule, it is absolutely imperative to permanently try to ease up the boat rather than to stress her.

You will always try to have the forward edges of the sails facing the apparent wind, and to have the sail not sheeted home, so that the airflow behind the sail may be laminar, that is to say so that it may go off the aft part of the sail without any disruption.

In case you shouldn't follow the recommendations below, it might be dangerous for the boat and the crew, and, in case of an accident, the manufacturer's responsibility would not be involved.

- TRIMMING WHEN CLOSE HAULED (between 75 and 50° of true wind)

Wind force given in apparent wind

- **From 0 to 16 knots:** full sail; sheet traveller 30 cm above the centre line of the boat, mainsail sheeted with a slightly open leech (boom on the centre line of the boat).

The genoa is trimmed so that it skims the spreader, the genoa traveller is set so that the angle of the genoa sheet is the continuation of a straight line that goes through the sheet clew and the luff, at 40% of its height.

- **From 16 to 20 knots:** full sail; the sheet traveller goes up 60 cm above the centre line of the boat, mainsail sheeted with a leech a little more open (boom always in line: therefore you must ease off the sheet). The genoa traveller remains at the same place but the sheet is adjusted so that the leech is 10 cm far from the spreader.

- **From 20 to 26 knots:** 1 reef, full genoa; the sheet traveller goes back to 30 cm above the centre line of the boat. The genoa traveller remains at the same place but the sheet is eased off so that the leech is 20 cm far from the spreader.

- **From 26 to 30 knots:** 1 reef, 75% of the genoa; the sheet traveller goes up 60 cm above the centre line of the boat. The genoa traveller remains at the same place or slightly goes forward but it is adjusted so that the leech makes a propeller shape where the upper part let some air go off in increases of wind.

- **From 30 to 36 knots:** 2 reefs, 60% of the genoa; the sheet traveller is back 30 cm above the centre line of the boat, the sheet is 50 cm eased off and the boom is leeward.

SAILS

■ Sails

Sail surface close hauled.....	134 m ² / 1071 sq.ft
Fully battened mainsail.....	82.50 m ² / 888 sq.ft
Square top mainsail (optional extra).....	85 m ² / 915 sq.ft
Furling genoa.....	51.80 m ² / 557 sq.ft
Spinnaker (optional extra).....	190 m ² / 2044 sq.ft
Gennaker (optional extra).....	105 m ² / 1130 sq.ft

I.....	17,746 m / 58'3"
J.....	4,698 m / 15'5"
P.....	17,653 m / 57'11"
E.....	6.630 m / 21'9"

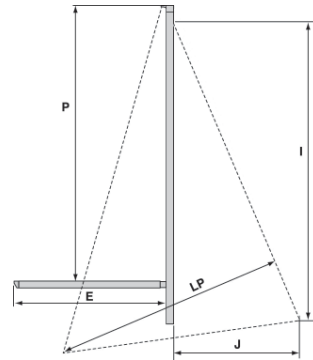
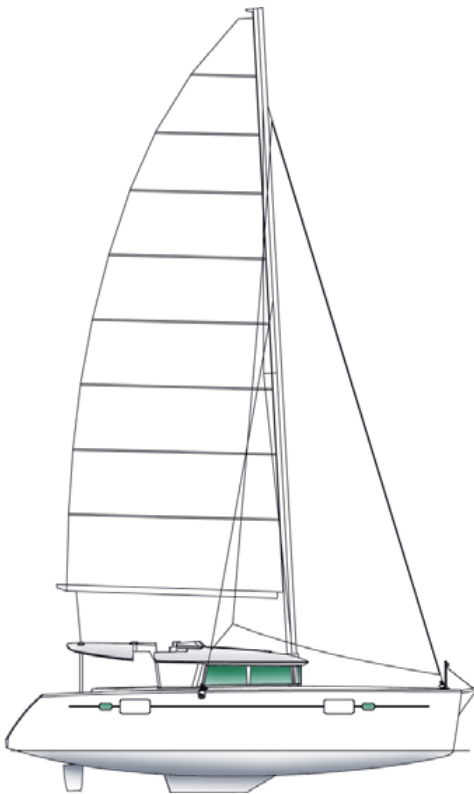

- From 36 to 45 knots: 2 reefs, genoa 40%. The sheet traveller is on the centre line of the boat, the sheet is 1 metre eased off and the boom is leeward.

The genoa traveller goes slightly forward, the sheet is eased off in order to open wide in gusts.

- From 45 to 55 knots: 3 reefs only (or try sail, or lying to), the traveller is on the centre line of the boat, the sheet is 1 metre eased off and the boom is leeward.

The boat would be more at ease scudding in such a weather.

- Over 55 knots: lying to, sea anchor, or preferably scudding.

• TRIMMING WHEN DOWN WIND (between 75 and 130° of true wind)

- From 0 to 23 knots: full sail; the traveller can be set at different places ranging from 1 metre off the centre line of the boat to the end of the track, depending on the angle of the wind, the sheet is eased off so that the boom may be leeward and 50 cm far from the traveller in dead calm then up to 2 metres when the wind strengthens.

In all the cases, you will avoid having more than one batten chafing against the upper shroud, in the fairest points of sailing.

The genoa is eased off in order to have its average front edge facing the apparent wind.

- From 23 to 28 knots: 1 reef, full genoa. The trimmings are similar.

- From 28 to 33 knots: 2 reefs, 80% of the genoa. The trimmings remain similar.

- From 33 to 38 knots: 2 reefs, 60% of the genoa. The trimmings remain similar.

- From 38 to 45 knots: 3 reefs (or mainsail lowered and slightly more genoa), genoa 40%. The trimmings remain similar.

- From 45 to 55 knots: mainsail lowered, genoa 40 to 30% quite hardened in order to avoid flapping.

- Over 55 knots: scudding, depending on the sea, you will set mooring ropes from one transom extension to the other one in order to reduce the speed of the boat.

These figures are given for reference only and are to be adapted regarding external conditions.

WARNING

If there is a radar aerial on the mast, keep an eye on the genoa when you put about or gybe in order to avoid any risk of damage.

• SQUARE TOP MAINSAIL

WARNING

A cruising square top mainsail is more powerful than a standard mainsail. Shorten the sails earlier, depending on the wind conditions.

RIGGING PLAN - MAST FOOT

RIGGING /
SAILS

32

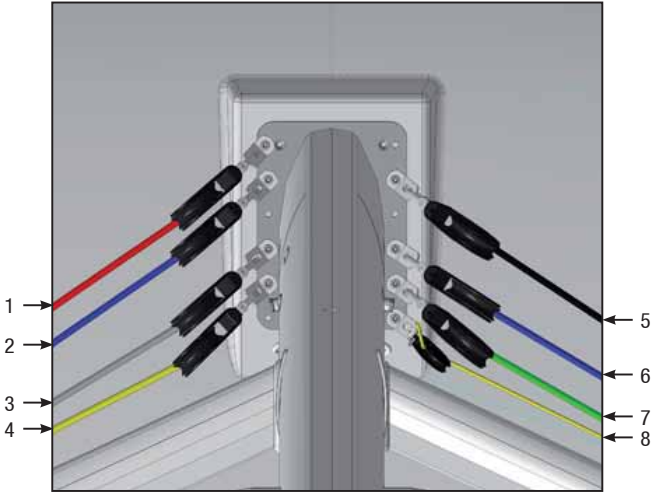

- 1 - Spinnaker halyard.
- 2 - Jib halyard.
- 3 - Mainsail topping lift.
- 4 - Reef 1.
- 5 - Mainsail halyard.
- 6 - Reef 3.
- 7 - Reef 2.
- 8 - Mainsail lowering rope.

LAGOON 450

■ 3.2 Standing rigging

The LAGOON 450 has been adjusted by the shipyard and by the mast manufacturer when first masting.

The cables stretch a little during the first sailings. Therefore it is advisable to have the mast inspected and adjusted by a specialist.

Before you put out to sea, it is essential to make sure that the standing rigging is in good condition: inspect the gooseneck, turnbuckles, and check the condition of the shrouds.

RECOMMENDATION

Any intervention on the standing rigging comes within a specialist remit.

To hoist a crew member up to the top of the mast, use the man hoisting halyard.

Belay the crew member with a bowline on the bosun's chair ring (do not use snap shackle or shackle).

WARNING

The man hoisting halyard which is the only one to be authorized for this purpose, is only meant to hoist a crew member up to the top of the mast.

Description of the ropes	length (m)	diametre (mm)
Genoa halyard	44	12
Genoa sheet	19 x 2	14
Main halyard	67	12
Mainsail topping lift	46	12
Mainsheet	34	14
Mainsail traveller adjustment	19 x 2	10
Reef 1 (automatic)	32	14
Reef 2 (automatic)	40	14
Reef 3 (manual)	36	14
Sheet + spinnaker guy	18 x 2	12
Gennaker sheet	29	14
Spinnaker / gennaker halyard	48	12

RUNNING RIGGING - MAINSAIL CIRCUIT

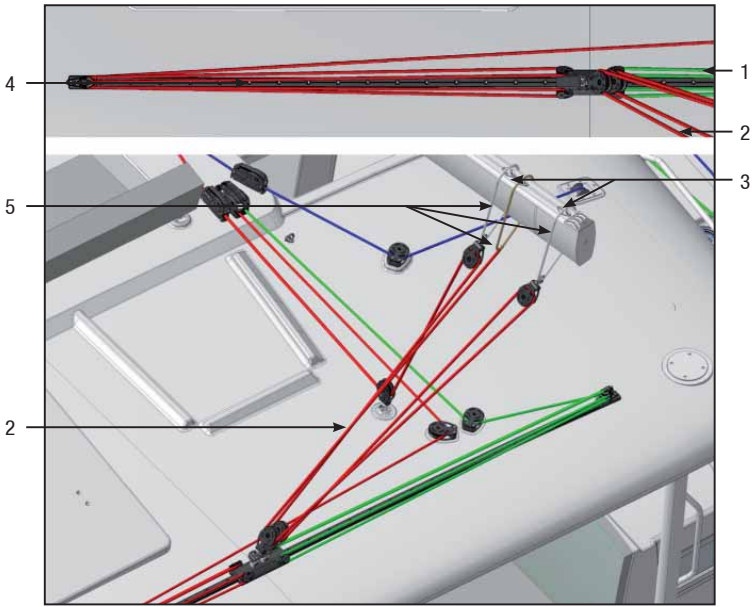

- 1 - Mainsail traveller adjustment / starboard.
- 2 - Mainsail sheet.
- 3 - Stropes.
- 4 - Mainsail traveller adjustment / port side.
- 5 - Stropes fastening.

■ 3.3 Running rigging

The mainsail, genoa and staysail sheets, the topping lift, the reefing lines, the mainsail and spinnaker halyards, the control lines for the main traveller are led back to the manoeuvre station.

- SHEET WINCHES AND MANOEUVRE WINCHES (MANUAL OR ELECTRIC) (OPTIONAL EXTRA)

The circuit breakers for the electric winches are located in the electrical room, in the starboard aft passageway.

RECOMMENDATION

Have at least 3 turns on the winch. Electrical winches generate an extremely powerful force and you should use them with much care. Never force when you find a jamming point. When using the winches, keep your hands away. After use, shut the switch covers.

WARNING

Refer to the manufacturer's instructions to remove the winches and put them back. Improper refitting may result in accidents (for example: kick of the crank handle).

■ 3.4 Sails

- STANDARD MAINSAIL

To hoist the standard mainsail:

- Point your boat into wind with engine in gear.
- Make sure that the mainsheet is eased off and the reefs are free.
- Open the jammer.
- Hoist the sail being careful for the battens not to get jammed in the lazy-jacks.
- Make fast the halyard with the jammer.
- Trim the mainsail according to the wind and sea conditions.

To lower the standard mainsail:

- Haul up.
- Tighten the topping lift.
- Slacken off the halyard, lower the mainsail then furl it.
- Tighten the sheet.

- REEFING A SAIL

On each reef, you will also find a stopper on the leech and on the tack.

- Move the mainsail closer to the eye of the wind, using the wheel or the traveller.
- Check the main sheet.
- Pick up the lift again.
- Slip the halyard.
- Tighten the tack pendant of the reef concerned till the lowest possible point, then close the jammer.
- Repeat the same maneuver with the reef tack stopper.
- Hoist the main sail home and shut the locker.
- Slip the lift.

RUNNING RIGGING SPINNAKER - GENNAKER

RIGGING /
SAILS

36

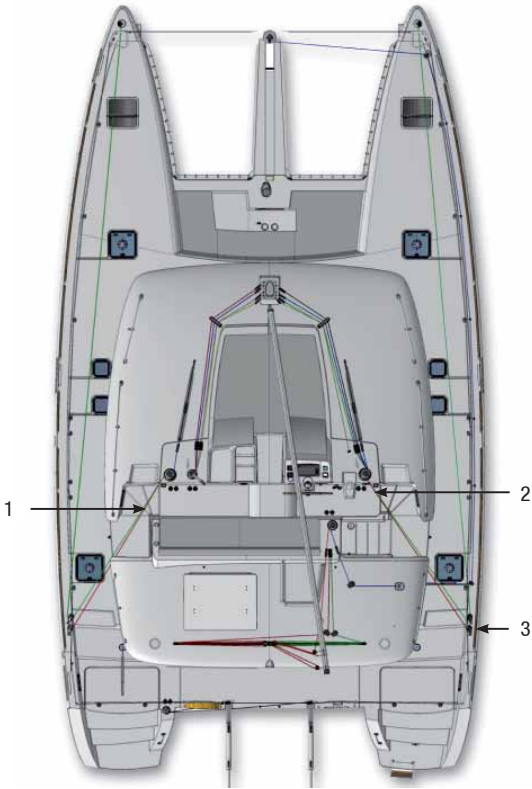

- 1 - Spinnaker guy.
- 2 - Gennaker / spinnaker sheet.
- 3 - Gennaker / spinnaker block.

LAGOON 450

REEF SHAKING OUT

- Make the mainsail closer to the eye of the wind, either steering the boat or using the traveller.
- Ease off the mainsheet.
- Tighten the topping lift.
- Ease off the tack and leech reef pendants.
- Hoist the mainsail, then close the jammer.
- Slacken off the topping lift.

• CRUISING SQUARE TOP MAINSAIL

The cruising square top mainsail halyard is lashed on the eyelet of the sail, not on the headboard traveller.

The square top will be properly set automatically once the sail is hoisted up.

FITTING OF THE MAINSAIL CRUISING SQUARE TOP SYSTEM

Refer to the drawing on the opposite page.

- Remove the pin of the headboard car (mark A).
 - Make the 2 strand tackle as per the drawing on the opposite page.
 - Put back the headboard car pin (mark A), adding the sheave.
- The length of the headboard line is adjusted to the right dimension for a new sail at the sailmaker's.

The lashing (mark D) makes possible to make up for the possible lengthening of the rope due to ageing.

Nota: this system is patented by the INCIDENCES sailmaker.

WARNING

A cruising square top mainsail has a more important power than a standard mainsail. Shorten the sail earlier depending on the wind conditions.

• ROLLER FURLING GENOA

Hoist the genoa before you get under way, taking advantage of a windless period of time.

- Secure the head.
- Secure the halyard to the slide-swivel.
- Secure the tack to the drum and secure the sheets.
- Insert carefully the bolt rope into the hole, hoist the sail and take care you do not tear it.
- Haul the halyard taut enough but sway it up less than a sail on a standard stay.
- Hoist it until the horizontal creases disappear (the tension of the luff shall be adjusted after a few sea trips).
- Pull on the line from the cockpit to furl the genoa.

RECOMMENDATION

Hand pre roll the drum to set the genoa furling line on it.

Pay attention to the drum furling direction: the sacrificial strip of the genoa shall be wrapped outside.

Never force when you furl or unfurl the head sails in case it seizes. Make sure a halyard is not caught in the roller furler.

CRUISING SQUARE TOP MAINSAIL

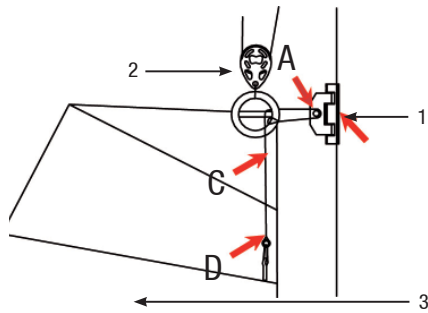

- 1 - Headboard traveller.
- 2 - Halyard block (to be fastened onto the headboard eye).
- 3 - Cruising square top mainsail.

**FASTENING OF THE CRUISING
SQUARE TOP MAINSAIL**



- GENNAKER

Remove the forward lifelines when using the gennaker (risk of damage).

Before getting under the way, take advantage of a windless period of time and hoist the gennaker.

- Secure the swivel to the gennaker headboard.
- Secure the furling system to the tack clew.
- Put the furling system to the boomsprit with a snap shackle.
- Secure the halyard to the headboard swivel.
- Hoist the gennaker.

Use the furling system line to furl or unfurl the gennaker.

Gennaker sheets:

- Secure the sheets to the gennaker clew.
- Have the sheets go on the outside of the stay and shrouds and above the guardrails.
- Make fast the sheet leading blocks to the chainplates.
- Reroute the sheets to the genoa sheet winches.

WARNING

In some sailing trims, the gennaker may hide the fore navigation lights.

WARNING

Unrig the gennaker when not in use (risk of being UV damaged and inadvertently unfurled).

ACCOMMODATIONS 4

4.1 Saloon - Galley

4.2 Lighting

4.3 Portholes - Deck hatches

4.4 Window blinds

LIGHTINGS - DRAWER

**LIGHTING SWITCHES
DIRECT - SALOON STARBOARD**

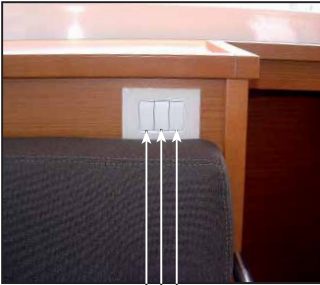

1 2 3

- 1 - Starboard front.
- 2 - TV set up / down (optional fitting).
- 3 - Port side front.

**LIGHTING SWITCHES
ENTRANCE STARBOARD**

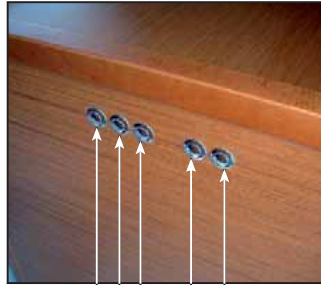

4 5 6 7 8

- 4 - Saloon starboard.
- 5 - Saloon front.
- 6 - Lighting indirect saloon.
- 7 - Lighting indirect - cockpit.
- 8 - Lighting - cockpit.

**REMOVING
THE DRAWER LEVER + RAILS**



■ 4.1 Saloon - Galley

- FLOORBOARDS

The floorboards can be lifted up to have access to the different technical components on board.

RECOMMENDATION

To avoid premature ageing of the floorboards (dents, scratches) it is recommended to keep them as clean as possible and to remove shoes inside the boat.

- TABLE

You can switch the saloon and cockpit tables around.

An optional fitting allows to turn the saloon table into a double berth after having changed the legs and added extra cushions.

- DRAWERS

The drawers in the galley have an automatic closing function.

Gently push the drawer till the movement ends itself.

These drawers can be removed pushing on the levers on each side, under the rails.

When you reassemble it, clip the drawer before you push it back.

■ 4.2 Lighting

There are many ways of lighting the saloon, directly or indirectly, depending on the atmosphere you want to create.

After having turned on the 12 V circuit on board and the lighting circuit using the switch located on the electrical panel next to the starboard entrance of the saloon, you can turn the light on.



PORTHOLES - HATCHES - WINDOWS

**LOCKING OF THE DECK HATCH
AND THE PORTHOLES**



**BLIND AND MOSQUITO
SCREEN ON DECK HATCH**



ACCOMMODATIONS

44

SHUTTER - SIDE WINDOW



SHUTTER - SALOON



LAGOON 450

■ 4.3 Portholes - Deck hatches

The portholes and deck hatches have locking systems to keep them in a closed position.

At anchor, intermediate opening position allows the ventilation of the boat.

The deck hatches are fitted with a blind and mosquito screen system that can be used even when the hatch is open.
Their handling shall be done carefully.

■ 4.4 Window blinds

All the windows have blinds.

The opening hatches of the aft cabin(s) are also fitted with blinds.

RECOMMENDATION

Pull and push the blinds carefully.

Take care to fasten them when they are fitted with the relevant systems.



UTILITY ABOARD

5

5.1 Refrigerators - Conservator - Icemaker

5.2 Microwave oven

5.3 Oven, hotplate

5.4 Dishwasher

5.5 Washer dryer

5.6 Television

5.7 Air conditioning system

5.8 Heating system

REFRIGERATORS - CONSERVATOR - ICEMAKER - MICROWAVE OVEN

UTILITY
ABOARD

48

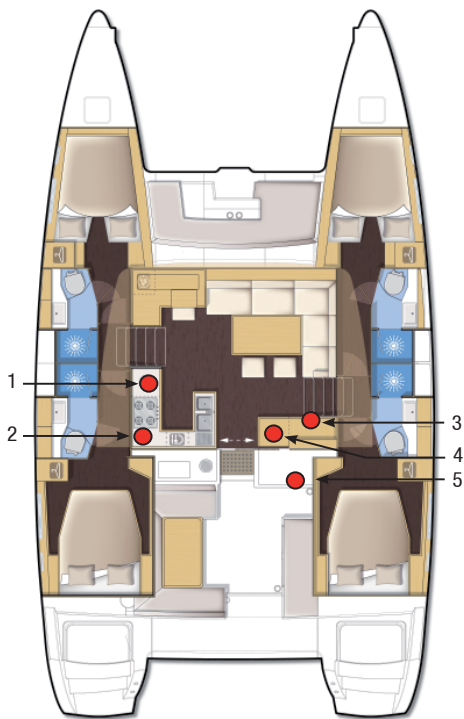

*Nota: the same layout can be observed
in the other version.*

**REFRIGERATOR -
COCKPIT (OPTIONAL)**



**REFRIGERATOR -
SALOON**



- 1 - Refrigerator.
- 2 - Microwave oven (optional extra).
- 3 - 110 V - 220 V selection panel.
- 4 - Refrigerator / conservator - saloon (optional extra).
- 5 - Refrigerator / icemaker - cockpit (optional extra).

LAGOON 450

■ 5.1 Refrigerators - Conservator - Icemaker

The boat standard features include a 130 l refrigerator located in the galley. It may optionally be fitted with a conservator (110 l) or another refrigerator (130 l) located in the cupboard in the saloon starboard entrance.

The boat may also be fitted with an optional refrigerator (80 l) or an icemaker located in the aft cockpit.

Once the general 12 V on board circuit has been powered, you can turn on the power for the different devices using the cold group switch located on the electrical panel located on the starboard side of the saloon.

• ICEMAKER USE

The icemaker requires 220 V.

It is supplied with water through the fresh water circuit.

- Check that its circuit breaker has been powered in the electrical room (in the cupboard in the starboard aft passageway).

POWER SUPPLY

Select the power supply source (generator or supply shore socket) using the left hand selector on the 110 V - 220 V selector board (in the cupboard at the saloon starboard side entrance).

Nota: the icemaker circuit is fitted with a filter (access under the starboard side aft passageway floor). Have this filter changed regularly.

For the use and maintenance of the refrigerator and freezer, please refer to their instruction guides.

RECOMMENDATION

Defrost then drain off the refrigerators and the conservator before cutting the 12 V circuit on board.

■ 5.2 Microwave oven (optional extra)

Depending on the fitting out, a microwave oven, located in the galley, can be provided (over the hob).

- Check the microwave plugging.
- Check that the sockets switches have been powered on the selection panel located in the saloon starboard entrance.

POWER SUPPLY

Select the power supply source (generator or supply shore socket) using the left hand selector on the selector board at the saloon starboard entrance.

For the use and maintenance of the microwave oven, please refer to its instruction guide.

OVEN - HOTPLATE - DISHWASHER - WASHER DRYER

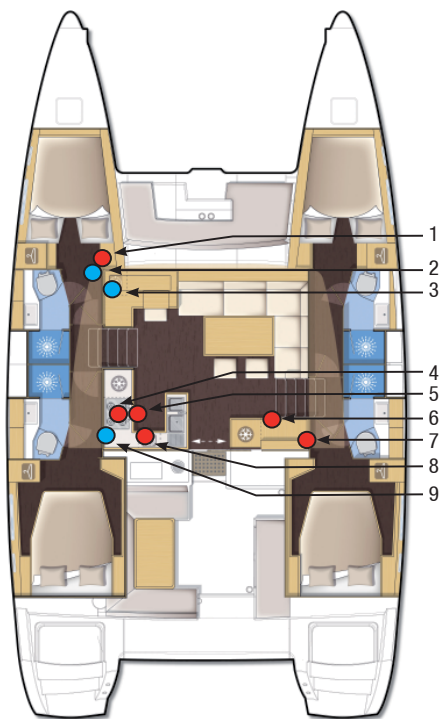

*Nota: the same layout can be observed
in the other version.*



1

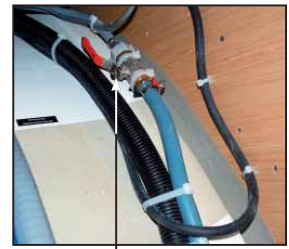

3

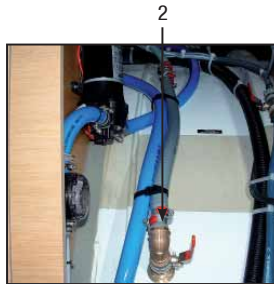

2

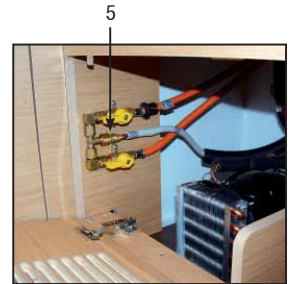

5

- 1 - Washer dryer (optional extra).
- 2 - Outlet valve of the washer dryer.
- 3 - Supply valve of the washer dryer.
- 4 - Oven + hotplate.
- 5 - Gas valves.

- 6 - 110 V - 220 V selection panel.
- 7 - Circuit breakers panel.
- 8 - Dishwasher (optional extra).
- 9 - Supply valve of the dishwasher.

■ 5.3 Oven, hotplate

The boat is standard fitted with a gas cooking hob.
The gas valves are located in the cupboard at the left of the oven.
The gas cartridges are located in the port side cockpit locker.

RECOMMENDATION

Shut the gas valves and the regulator tap when you do not use the hob.

■ 5.4 Dishwasher (optional extra)

The boat is fitted with an optional dishwasher located in the galley.
It is supplied with water coming from the fresh water system.
Drainage is made through the sink drainage system.
Check that the relevant fresh water inlet valve is open in the plumbing room (aft port side passageway).

- Check that the relevant circuit breaker has been powered in the electrical room (in the cupboard in the starboard aft passageway).

SUPPLY

Select the power supply source (generator or supply shore socket) using the left hand selector on the 110 V - 220 V selector board (in the cupboard at the saloon starboard side entrance).

For the use and maintenance of the dishwasher, please refer to its instruction guide.

■ 5.5 Washer dryer (optional extra)

The boat standard features include a washer-dryer located in a cupboard in the port side front cabin.

It is supplied with water coming from the fresh water system.
Check that the relevant fresh water inlet valve is open in the front port side passageway cupboard.
Drainage is made through the valve located in the front port side passageway cupboard.

- Check that its circuit breaker has been powered in the electrical room (in the cupboard in the starboard aft passageway).

SUPPLY

Select the power supply source (generator or supply shore socket) using the left hand selector on the 110 V - 220 V selector board (in the cupboard at the saloon starboard side entrance).

RECOMMENDATION

The washing machine shall not work while you are sailing.

For the use and maintenance of the washer-dryer, please refer to its instruction guide.

TELEVISION - AIR CONDITIONING

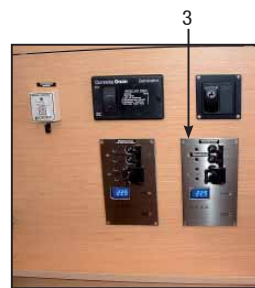
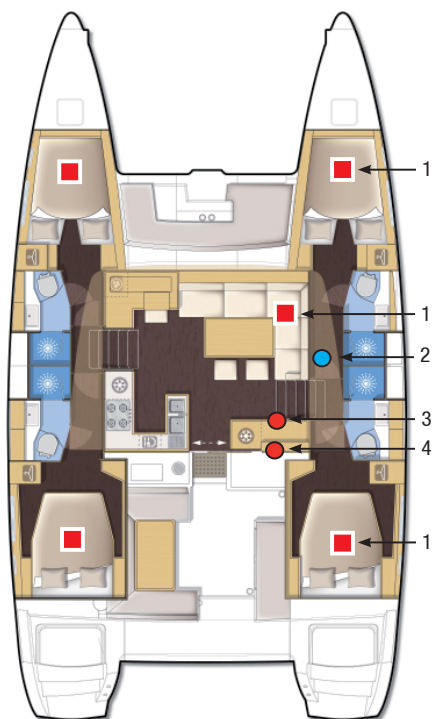

- 1 - Air conditioning unit.
- 2 - Sea water pump / Air conditioning.
- 3 - Selection panel / Air conditioning.
- 4 - Television.
- 5 - Air conditioning control.
- 6 - Seawater supply valve / Air conditioning.

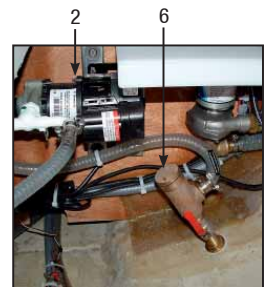

*Nota: the same layout can be observed
in the other version.*

■ 5.6 Television (optional extra)

The saloon may optionally be fitted with an electric TV lift. The owner's cabin may also be fitted with an optional TV. The TV sets are supplied with a converter.

After having turned on the 12 V on board circuit:

- Press the switch located next to the starboard companion ladder in order to make the TV go up or down.

Check carefully that nothing may block the TV trap.
Set the TV on its initial position when sailing.

An antenna booster is located next to the pillar, behind the back of the saloon seating.

For the use and maintenance of the television, please refer to its instruction guide.

■ 5.7 Air conditioning system (optional extra)

The boat may be fitted with an optional reversible air conditioning system.

The air conditioning units are located in the cabins and in the saloon. You will find vents in every cabin and in the saloon.

Before you start the system:

Open the sea water circulation system (suction valve in the sump and direct drainage).

SUPPLY

Select the power supply source (generator or supply shore socket) using the right hand 110 V - 220 V selector board located in the cupboard at the saloon starboard entrance.

Check that the pumps and air conditioning groups are turned on or the circuit breakers located in the electrical room in the aft starboard passageway.

Start the air conditioning unit in the desired area, select hot or cold and set the temperature using its control.

Regularly clean the filters on the conditioned-air systems and sea water suction valves.

For the drainage, use and maintenance of the air conditioning system, please refer to its instruction guide.

HEATING SYSTEM

UTILITY
ABOARD

54

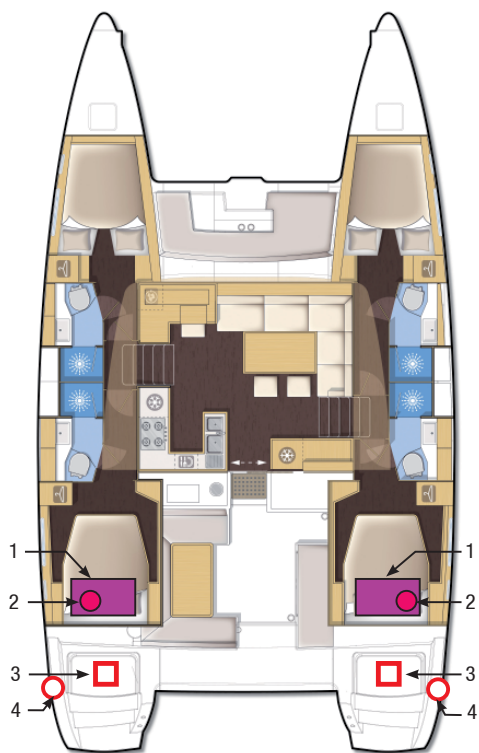

*Nota: the same layout can be observed
in the other version.*

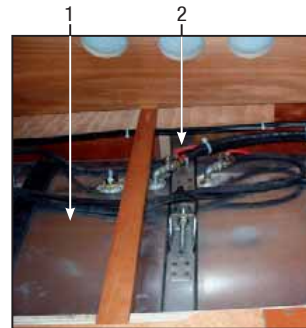

- 1 - Fuel tanks.
- 2 - Fuel valves.
- 3 - Boilers.
- 4 - Boiler exhaust outlet.

LAGOON 450

■ 5.8 Heating system (optional extra)

The boat may optionally be fitted with a diesel heating system with circulating water.

The boilers are located in the engine compartments both starboard and port sides.

- Check the fuel valve is open (access on the tanks in the starboard and port side aft cabins).
- Start each boiler then set the temperature using their controls.

For the use and maintenance of the heating system, please refer to its instruction guide.

WARNING

Be careful not to set any fender in front of the heating boiler exhaust outlets.



WATER SYSTEMS

6

- 6.1 Bilge pump system**
- 6.2 Grey waters**
- 6.3 Black waters**
- 6.4 Fresh water**
- 6.5 Watermaker**

BILGE PUMP SYSTEM - GREY WATERS

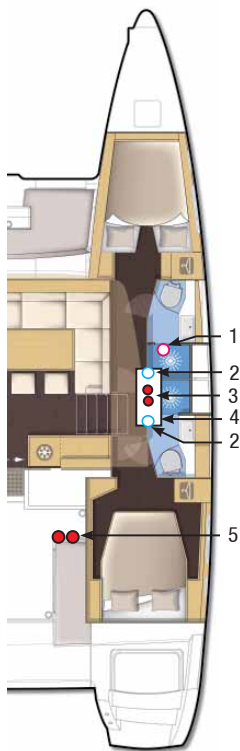

Nota: the same layout can be observed in the other version.

- 1 - Shower pump switch.
- 2 - Front / aft compartment outlet valve.
- 3 - Electric bilge pumps.
- 4 - Hull sump.
- 5 - Manual bilge pumps.
- 6 - Shower drain valve.

Each hull has the same components.

Nota: each valve in the boat is identified.

SEA-COCK OPEN



SEA-COCK CLOSED

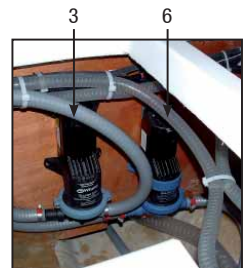
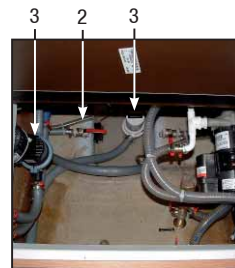
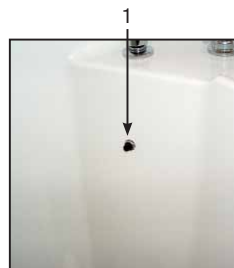

■ 6.1 Bilge pump system

A main sump is under the floorboard of each hull. The fore and aft compartments are linked to these sumps by a bilge pipe and a valve (access under the floorboards).

Each well is emptied by three bilge pumps:

- A manual cockpit pump.
- An electric pump with manual release from the electrical board.
- An electric pump with manual and automatic release located in the well.

RECOMMENDATION

Regularly check the valves and sea-cocks for proper operation and watertightness. Regularly make sure the filters and strainers on the draining system are clean.

WARNING

The bilge pump system is not designed to provide buoyancy to the boat in case of damage. The bilge pump system is designed to drive out the water being either sea spray or leaks but absolutely not the water coming through a hole in the hull, this hole being the result of a damage.

RECOMMENDATION

Always keep the bilge pumps switched on the automatic mode with alarm. We advise you to test the bilge pumps every time you put out to sea.

■ 6.2 Grey waters

The grey waters (sink, washbasins) directly flow out via sea-cocks with valves.

Please note: a valve is closed when its handle is perpendicular to the hose and it is open when its handle is in line with the hose.

Grey waters coming from the showers are emptied through pumps located under the floors of the starboard and port passageways. The pumps are switched on from the 12 V domestic circuit.

In order to empty the showers, use the pump switch located on the wet room cupboard.

RECOMMENDATION

When mooring in a harbour, if possible, use the sanitary facilities provided by the port authority. In some harbours or countries, wastewater disposal is forbidden. You will then have to use the waste tank.



BLACK WATERS

WATER SYSTEMS

60

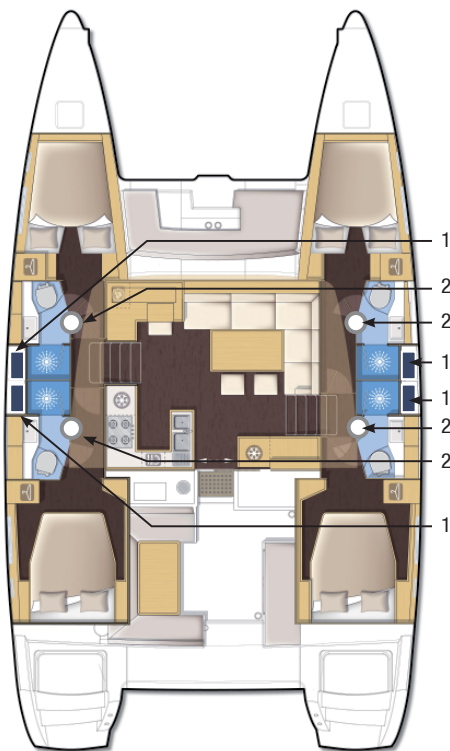

*Nota: the same layout can be observed
in the other version.*



- 1 - Holding tank.
- 2 - Drain valve on hull.
- 3 - Switches of the electric toilets.

LAGOON 450

■ 6.3 Black waters

The boat is fitted with manual toilets and a holding tank in the port aft washroom, as standard equipments.

She may be fitted with optional electric toilets and holding tanks in all the washrooms.

- USE OF THE MANUAL TOILETS

Open the water inlet and drain valves.

To empty the bowl:

- Set the control lever of the pump slantwise (FLUSH) and operate the pump.

To dry the bowl:

- Set the lever back vertical (DRY) and operate the pump.

In order to avoid clogging the toilets, use absorbent paper only and pump until the emptying hose is completely empty.

Regularly rinse the toilets with fresh water.

Close the valves after each use.

- USE OF THE ELECTRIC TOILETS

The electric toilets are rinsed with sea water.

The electric pump, its filter and the supply valve are located in the washroom cabinet.

- Switch on the 12 V domestic circuit.

- Open the water inlet and drain valves.

One of the switches next to the toilets makes possible a water intake cycle and a water outlet cycle.

The second switch makes possible to carry out a rinse cycle.

Rinse the toilets with fresh water and regularly clean the filters.

Close the valves after each use.

For the use and maintenance of the electric toilets, please refer to their instruction guide.

- USE OF THE HOLDING TANKS

Tanks can be reached through the wet rooms.

Make sure the drain valve of the tank is closed in order to avoid any inadvertent discharge (the valve is closed when the handle is perpendicular to the hose).

Tank drainage:

- In an authorized area, open the drain valve.

- In a marina equipped with an organic waste suction system, fit the suction hose into the tank through the deck filler.

- Start the pump of the suction system.

Regularly rinse the holding tank.

The tanks shall be emptied when the boat is berthed in negative temperatures.

WARNING

Use the suction systems in marinas to empty your holding tank. In order to respect environment, do not discharge your holding tank near the shore.



FRESH WATER

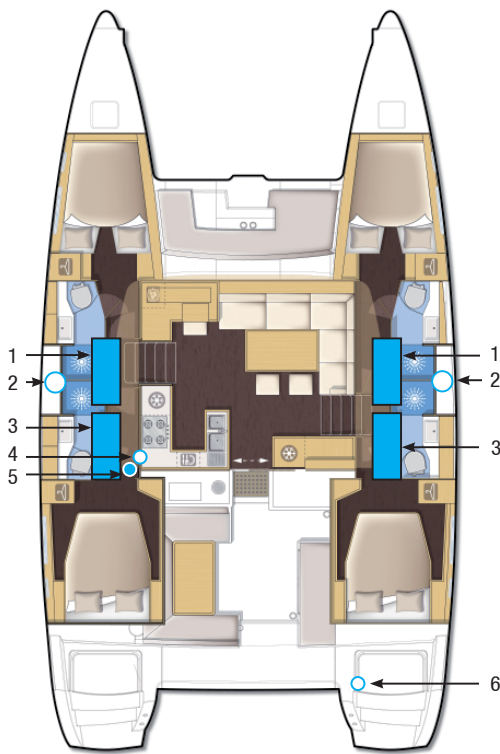

Nota: the same layout can be observed in the other version.

- 1 - Port / Starboard forward tank.
- 2 - Deck filler.
- 3 - Aft tanks (optional extra).
- 4 - Valves for the selection of the tanks.
- 5 - Pressure water pump.
- 6 - Shore fresh water supply.



6



4



5

■ 6.4 Fresh water

- FRESH WATER TANKS

The boat standard features include two 175 l tanks. The tank selector valve is located in the plumbing room in the port side aft passageway.

To prevent any handling mistake, never fill the water and fuel tanks at the same time.

Two front filling caps (starboard and port sides) allow the tanks to be filled up.

During filling, avoid handling contaminants near the fillers.

Open and close the filler caps with the right key.

Check the filler cap seals for condition during filling.

Never insert the water filling hose deep down into the system in order to prevent any over-pressure in the systems.

RECOMMENDATION

Pay attention to the quality of the water for the filling up.

Check if it is drinking water.

If the boat is not used for long, purify the tanks and pipes with proper treatment.

Please note: the capacity of the fresh water tank(s) indicated on the page 'SPECIFICATIONS' may be not completely usable depending on the trim and load of the boat.

- PRESSURE WATER PUMP

The water unit is located in the plumbing room in the port side aft passageway.

Its starting is done by using a switch on the electrical panel.

RECOMMENDATION

Never operate the water system equipment when the valves are closed or when the tanks are empty (the electrical equipment may be damaged). Check the different water filters for condition.

- WATER GAUGE

Watch the water level in the tanks using the gauge located on the electrical panel (in the cupboard in the saloon starboard entrance).

To switch from one tank to the other, press the "Water" button.

- SHORE FRESH WATER SUPPLY

The shore fresh water inlet valve is located in the starboard aft transom.

To use the marina fresh water:

- Connect the shore supply.
- Set the pressure water pump switch to 'OFF'.

RECOMMENDATION

When you leave the boat unattended, systematically disconnect the shore fresh water supply.



FRESH WATER - SEA WATER



*Nota: the same layout can be observed
in the other version.*

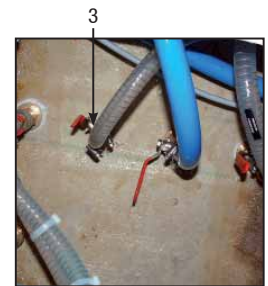
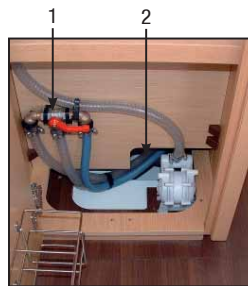

- 1 - Valve to select fresh water / sea water.
- 2 - Foot pump.
- 3 - Sea water supply valve.
- 4 - Water heater.
- 5 - Shower.

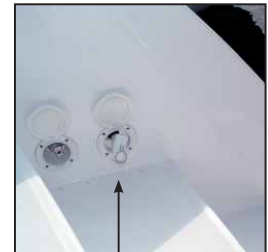

WATER SYSTEMS

- **FRESH WATER / SEA WATER FOOT PUMP**

The foot pump makes possible to supply a tap of the sink with fresh water and sea water.

The 3-way fresh / sea water valve can be reached through the sink unit.

In case of foot pump hardening, check if the water supply hose is not blocked, or if the tap is not choked.

In the latter case, remove the tap end and clean it.

- **EXTERIOR SHOWER**

A shower supplied with hot and cold water (mixing faucet) is located on the starboard side of the transom.

It is supplied by the pressure water pump.

WARNING

In period of frost, do not forget to empty the cockpit shower, even if there is someone onboard the boat.

- **WATER HEATER**

The water heater is located in the port side cabin.

It has a capacity of 60 liters.

The water heater functions automatically when the engine is on or when set on the 110 V - 220 V circuit (generator or shore supply socket) after having activated its circuit breaker on the electrical panel in the saloon starboard side.

The hot water temperature is pre-set using the thermostatic tap located on the water heater.

RECOMMENDATION

When the water heater is not used, switch it off using its 110 V - 220 V circuit.

Before you switch it on using the 110 V - 220 V circuit, check the water heater is full of water.



WATERMAKER

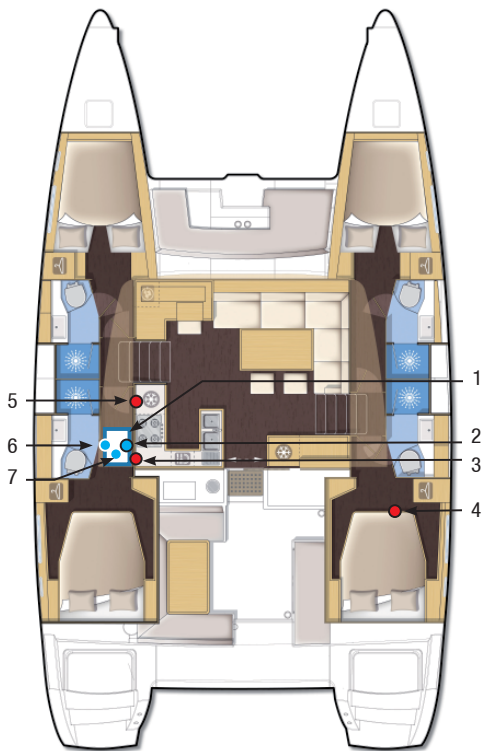

Nota: the same layout can be observed in the other version.



2



4



5

- 1 - Watermaker.
- 2 - Valves to select the tanks port / starboard.
- 3 - Watermaker low pressure pump.
- 4 - Automatic breaker.
- 5 - Control.
- 6 - Sea water supply valve of the watermaker.
- 7 - Filter.

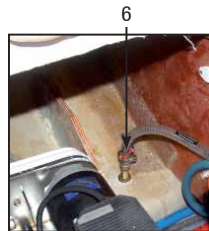

6

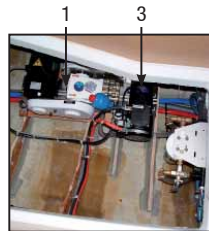

1

3

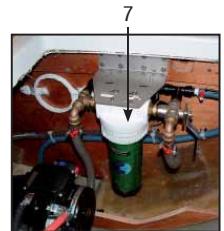

7

■ 6.5 Watermaker (optional extra)

The boat may optionally be fitted with a water maker (100 l / hour) located under the port side passageway floor.

OPERATION

The watermaker works either in 12 V, or in 110 V - 220 V.

Check that the relevant circuit breaker located in front of the starboard berth has been powered.

Check its sea water supply valve is open (access under the floor of the port side passageway).

SUPPLY

Select the power supply (12 V or 110 V - 220 V) using the selector on the water maker control panel (access in the port side passage way).

Then, select the power supply source (generator or supply shore socket) using the left hand selector on the 110 V - 220 V selector board (in the cupboard at the saloon starboard side entrance).

Select the tank to be filled up using the relevant valve (access in the port side passage way).

Start the water maker using its control located on its panel.

Check the level of fresh water in the tanks when the watermaker is working.

Regularly clean the filter located under the floor of the port side passageway.

RECOMMENDATION

The watermaker shall be used exclusively in clear waters and preferably when at anchor.

For the use and maintenance of the watermaker, please refer to its instruction guide.



ELECTRICITY

7

- 7.1 12 V circuit**
- 7.2 Inverters**
- 7.3 110 V - 220 V circuits**
- 7.4 Electronics**

12 V ELECTRICAL PANELS - BATTERY CHARGERS - INVERTER

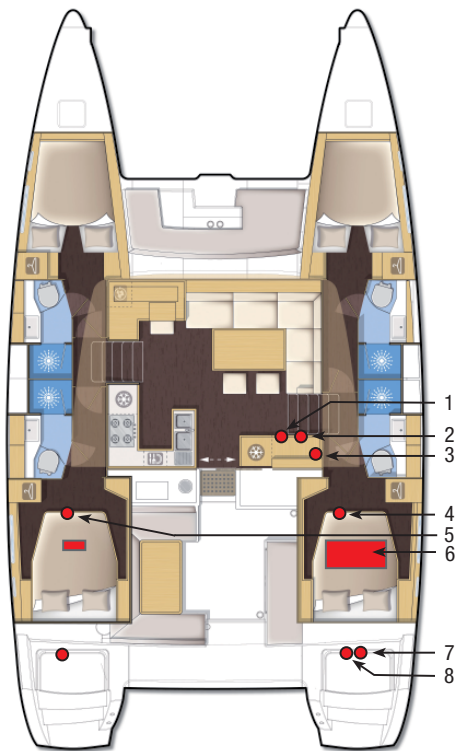

Nota: the same layout can be observed in the other version.



2



3

- 1 - Electrical panel.
- 2 - Switch of the inverter.
- 3 - 12 V / 110 V - 220 V inverter.
- 4 - Boat and 12 V engine cutouts.

- 5 - Cut out coupling /engine battery port / starboard.
- 6 - 12 V batteries.
- 7 - Battery chargers.
- 8 - Load balancer.

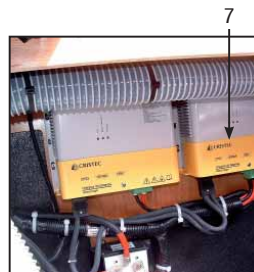

7

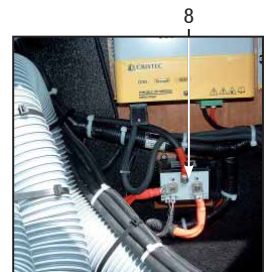

8

An electricity manual is delivered with the boat. This manual includes the diagrams and technical explanations on the electrical systems. Please refer to this electricity manual to get any information that is not dealt with in this instruction guide.

■ 7.1 12 V circuit

The main domestic circuit is supplied in 12 V.

12 V batteries are located under the berths in the starboard and port side aft cabins.

Board and engine cut outs are located at the front of the berths of the starboard and port aft cabins.

For safety reasons, a coupling system for the engine batteries (cut out located at the front of the berth in the port side aft cabin) allows the engine to start if the relevant battery is faulty.

The generator has its own cut outs located in the starboard locker of the front deck.

The batteries can be charged either by the engine alternator or by the 110 V - 220 V / 12 V - 60 A battery charger. According to the layout, the boat may optionally be fitted with an extra 110 V - 220 V / 12 V - 40 A charger.

The battery chargers are located in the starboard engine compartment.

The battery charger for the generator is located in the generator room in the starboard locker of the fore deck.

They can be used either with the shore power supply or the generator.

SUPPLY OF THE CHARGERS

Select the power supply source (generator or supply shore socket) using the left hand selector on the 110 V - 220 V selector board located in the cupboard at the saloon starboard side entrance.

The 12 V consuming appliances circuit breakers are located behind the electrical panel.

They can be wound by pressing a black lug.

■ 7.2 Inverters

The boat may optionally be fitted with a 12 V / 110 V - 220 V converter located in the cupboard in the starboard aft passage way (electrical room).

The converter switch is located at the left hand of the selection panel (in the cupboard at the saloon starboard side entrance).

The converter supplies the galley sockets with 110 V - 220 V.



SHORE POWER SOCKETS - GENERATOR

GENERATOR CONTROL



AUTOMATIC BREAKERS OF THE SHORE POWER SOCKETS



GENERATOR

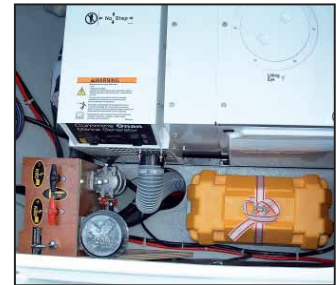

ELECTRICITY

72

**TANK / GENERATOR SELECTION
PULL ROD**



**WATER INLET VALVE
OF THE GENERATOR**



**WATER FILTER + FUEL FILTER
OF THE GENERATOR**



LAGOON 450

■ 7.3 110 V - 220 V circuits

• SHORE POWER SOCKETS

Both shore supply sockets are located in the starboard transom. They supply firstly the 110 V - 220 V circuit and the battery chargers and secondly the air conditioning system.

Before you plug in or unplug the boat / shore power supply cable, switch off the shut off device connected to the shore supply. Connect the boat / shore power supply cable in the boat before connecting it to the shore supply socket. Unplug the boat / shore supply cable on shore first. Close the protecting cover of the shore supply socket when you do not use the plug.

WARNING

Before using the shore power socket of a quay, you must check it is operated under a 32 Ah current.

DANGER

Never let the end of the boat / shore supply cable hang in the water; the result may be an electric field liable to hurt or kill the swimmers nearby.

The shore power plants are protected by circuit breakers located in the starboard engine compartment.

• GENERATOR

The generator is located in the starboard locker of the front deck. Its function is to re-supply the batteries via the chargers and supply 110 V - 220 V electricity on board.

OPERATION

After having turned ON the cut-outs located in the starboard locker of the front deck, the generator can be turned on either on the generator itself or using its control located under the electrical panel in the starboard entrance of the saloon.

- Check that the relevant sea water cooling valve is open (access under the starboard passageway floor). Select the fuel tank using the pull rod located next to the generator main switch in the front deck locker.

For the use and maintenance of the generator, please refer to its instruction guide.



ELECTRICAL PANELS - SELECTORS - AUTOMATIC BREAKERS

ELECTRICAL PANELS



**CONSUMING APPLIANCES
CIRCUIT BREAKERS**



**110 V - 220 V SUPPLY
SELECTION PANEL**



- CHECKING OF THE 110 V - 220 V CONSUMING APPLIANCES SELECTION PANEL (in the cupboard at the saloon starboard entrance): The panel is composed of selectors allowing to choose the electrical power source for the different 110 V - 220 V consuming appliances on board.

LEFT-HAND SIDE SELECTOR:

- allows to use the air conditioning powered by a 110 V - 220 V current coming from the generator or from the shore power.

RIGHT-HAND SIDE SELECTOR:

- allows to use the appliances requiring a 110 V - 220 V current coming from the generator, the shore power or the inverter.

RECOMMENDATION

Keep an eye on the charge of the batteries when you use the inverter.

- USE OF THE 230 V POWERED APPLIANCES

SWITCHING ON THE APPLIANCES

In order to be able to use the 110 V - 220 V powered appliances (washing machine, watermaker, etc), it is advisable:

Make sure that the outlet automatic breaker is switched OFF on the 110 V - 220 V selection panel.

- Switch on the 110 V - 220 V source (start the generator or connect a shore power socket to shore). Select this source on the selection panel so that this source supplies the boat (110 V - 220 V electrical selection panel) or turn on the inverter for the outlets.

- Push the automatic breakers of the outlets to be used on the electrical panel.

Then start the appliance with its own controls.

To start 110 V - 220 V elements, wait for 10 to 15 seconds between the start up of each new component (in order to allow the generator to become stabilized and be able to give the power necessary for the starting up).

STOPPING THE 110 V - 220 V POWERED APPLIANCES

To stop the 110 V - 220 V powered appliances (washing machine, etc.) it is advisable to do as follows:

- Stop the appliance with its own controls.

To stop 110 V - 220 V elements, wait for 10 to 15 seconds between the stop of each new component (in order to allow the generator to become stabilized).

- Turn OFF the automatic breakers of the outlets on the electrical panel.
- Turn to OFF the 110 V - 220 V source selector (generator or shore power) or turn off the inverter.
- Stop the generator or disconnect the shore power socket.

WARNING

Before you turn the 110 V - 220 V source selector to OFF, make sure no other appliance is working (danger of an electric arc that would destroy the changeover switch and risk of damaging the generator).



ELECTRONICS

ACCESS TO THE AUTOMATIC PILOT



AUTO PILOT FUSE



CALCULATOR



ELECTRICITY

AUTOMATIC PILOT COMPASS



SPEEDO LOG



LAGOON 450

■ 7.4 Electronics

The boat may be fitted with an optional electronic pack and different navigation aid accessories.

For the use and maintenance of all these components, please refer to their instruction guides.

The ram, the auto pilot and the calculator are located in the starboard engine compartment.

The auto pilot ram is located under the starboard aft berth.

The compass is located in the port side engine hold.

The speedo log (optional fitting) is located under the floor in the port side front cabin.



ELECTRIC LAYOUT

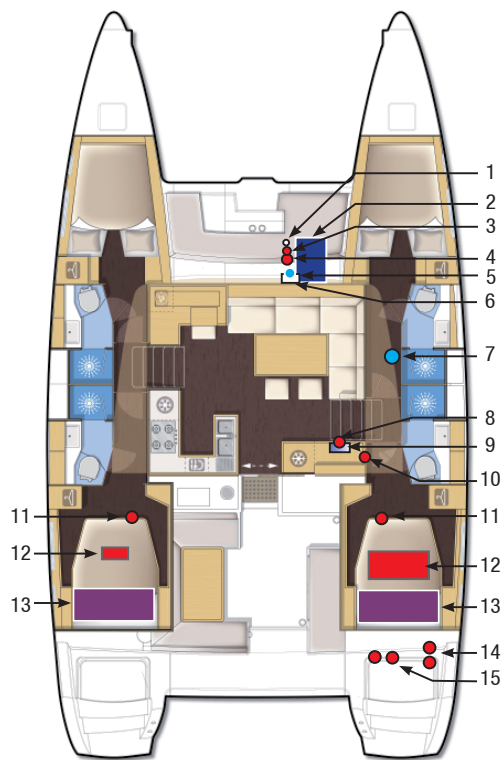

*Nota: the same layout can be observed
in the other version.*

- 1 - Fuel tank selection pull rod port / starboard.
- 2 - Generator.
- 3 - 12 V generator cutouts.
- 4 - Generator fuel filter.
- 5 - Generator water filter.
- 6 - 12 V battery chargers / Generator.
- 7 - Generator water inlet valve.
- 8 - Generator control.
- 9 - Electrical panel.
- 10 - Inverter.
- 11 - Cut outs board / engine + coupling.
- 12 - 12 V Batteries port / starboard.
- 13 - Fuel tanks port / starboard.
- 14A - 110 V - 220 V shore power socket / Air conditioning.
- 14B - 110 V - 220 V shore power socket / Board.
- 15A - Automatic breakers of the shore power sockets / Board.
- 15B - Automatic breakers of the shore power sockets / Air conditioning.

SUMMARY FOR THE 12 V COMPONENTS

CHARGE AND ELECTRICAL CONVERSION

1 x 220 V / 12 V - 60 A charger	12 V service bank + engine
1 x 220 V / 12 V - 40 A charger (optional extra)	Engines + board
1 x 220 V / 12 V - 25 A charger (optional extra)	Generators
2 x 12 V - 80 A alternator	Recharge service bank, batterie engines, generator

BATTERIES / CONSUMING APPLIANCES

12 V CURRENT	VOLTAGE	START + PROTECTION	PROTECTION
Service batteries	12 V - 440 Ah (maximum)		
Navigation electronics	12 V	12 V electrical panel	
Lighting	12 V	12 V electrical panel	
Navigation lights	12 V	12 V electrical panel	
Refrigerators, conservator	12 V	12 V electrical panel	
Electric toilets	12 V	12 V electrical panel	
Deckwash pump	12 V	12 V electrical panel	
Bilge pumps	12 V	12 V electrical panel	
Winches	12 V	12 V board	Electrical room
Windlass	12 V	12 V board	Starboard aft cabin
VHF	12 V	12 V board	12 V terminal bloc
Hifi	12 V	12 V board	12 V terminal bloc
Car radio	12 V	12 V board	12 V terminal bloc
12 V sockets	12 V	12 V board	12 V terminal bloc
Engine battery (x2)	12 V - 110 Ah		
Generator battery	12 V - 110 Ah		
Domestic battery	12 V - 140 Ah		

SUMMARY FOR THE 110 V - 220 V COMPONENTS

GENERATOR

Force 4 Kva - 11 Kva	100% of its charge in 220 V - 50 Hz
Force 5 Kva - 13,5 Kva in 110 V	100% of its charge in 110 V - 60 Hz

SHORE POWER SOCKET

Shore power socket Board 220 V - 50 Hz	32 A simple shore power socket	Starboard transom connection
Shore power socket Air conditioning 220 V - 50 Hz	32 A simple shore power socket	Starboard transom connection
Shore power socket Board 110 V - 60 Hz (version US)	32 A simple shore power socket	Starboard transom connection
Shore power socket Air conditioning 110 V - 60 Hz (version US)	32 A simple shore power socket	Starboard transom connection

ELECTRIC DISTRIBUTION

Selector #1 (on the right)	Air conditioning supplied by generator or shore power
Selector #2 (on the left)	Board supplied by generator or shore power (or 12 V / 220 V - 2000 W inverter)

CHARGE

1 x 220 V / 12 V - 60 A charger	Recharge of the service bank by generator or shore power
1 x 220 V / 12 V - 40 A charger optional extra	Engine battery charger supplied by the generator or the shore
1 x 220 V / 12 V - 25 A charger optional extra	Generator battery charger supplied by the generator or the shore

SUMMARY FOR THE 110 V - 220 V COMPONENTS

CONSUMING APPLIANCES	VOLTAGE	BOAT ELECTRICAL PANEL
Television	220 V	its own inverter
Outlets	220 V	Inverter or 220 V panel
Water heater	220 V	Panel 220 V
Dishwasher	220 V or 110 V	Panel 220 V
Washer dryer	220 V or 110 V	Panel 220 V
Icemaker	220 V or 110 V	Panel 220 V
Watermaker	220 V or 110 V	Panel 220 V
Air conditioning	220 V	Panel 220 V

MOTORIZATION

8

- 8.1 Engines**
- 8.2 Fuel**
- 8.3 Propellers - Anodes**
- 8.4 Dash board**
- 8.5 Optional controls**

ENGINE LAYOUT

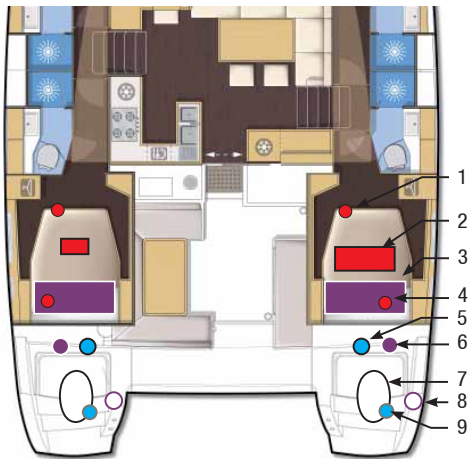

- 1 - Engine cut outs + coupling (port).
- 2 - 12 V battery.
- 3 - Fuel tank.
- 4 - Fuel valve.
- 5 - Sea water filter.
- 6 - Fuel filter.
- 7 - Engine.
- 8 - Diesel oil tank fillers.
- 9 - Engine water inlet valve.

Each hull has the same components.

Nota: each valve in the boat is identified.

MOTORIZATION

84

*Nota: the same layout can be observed
in the other version.*

COUPLING CUT OUTS

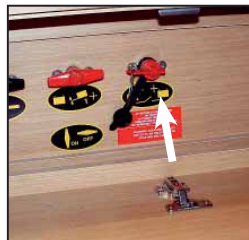

ENGINES CONTROLS



LAGOON 450

■ 8.1 Engines

- ACCESS

You have access to the engines through the transom extension hatches.

ATTENTION

Stop the engines before opening the hatches. In case you have to intervene when the engines are running:

- Stay away from belts and mobile parts.
- Be careful with full clothes, long hair, rings, etc. (they may be caught).
- Wear appropriate clothes (gloves, caps, etc.).

- STARTING

Before starting the engines:

- Check the fuel valves are open (access under the aft cabins berths, on the port and starboard tanks).
- Open the valves of the engine cooling system.
- Switch on the electrical circuit, setting the engines cutouts to 'ON' (access at the bottom of the starboard and port side berths).
- After having checked that the reverser handles are set on neutral, start the engines.

Please carefully read the engine instruction guide supplied with the boat; it gives you detailed explanations as to the best use of the engines and relative operations.

- ENGINE START WITH BATTERY COUPLING

In case one of the start batteries is not available:

- Activate (ON position) the coupling cut out located at the bottom of the port side berth.
- Start the engine concerned.
- Turn the coupling cutout back to the OFF position.

Nota: in the standard configuration, the engine batteries are recharged by their respective engines.

- ENGINES MAINTENANCE

Please follow the instructions for maintenance appearing in the guide supplied with the engines.

- ENGINE WATER INLETS

The water inlet valves of the engines (access through the engine holds) shall absolutely be open before you start the engines.

Keep the strainers of the engine water inlet valves in the best possible state of cleanliness.

Brush the strainers when the boat is careened.

Be careful: do not cover the strainers with antifouling paint.

Get used to checking immediately after starting the engines if water is expelled with the exhaust gases.

If water does not flow out:

- Stop the engines immediately.
- Check the valves are open.

Close the water inlet valves if the boat is left unattended for long.

Inspect and clean the water strainers regularly (access through the engine holds).



FUEL

FUEL GAUGE



WATER FILTER + FUEL FILTER



TANK + FUELLING VALVE



- VENTILATION OF THE ENGINE BAY

The engine bay fans start up automatically as soon as the engines start.

■ 8.2 Fuel

- FUEL TANKS

The boat is fitted with two tanks.

Each of them is filled separately.

Check the fuel gauge of each tank on the electrical board.

To switch from one tank to the other, press the "Fuel" button.

- FILLING

To prevent any handling mistake, never fill the water and fuel tanks at the same time.

During filling, avoid handling contaminants near the fillers.

Open and close the filler caps with the right key.

Use both fillers to fill the tanks with fuel.

DANGER

Stop the engine and put out your cigarettes when you are filling the fuel tanks.

- MAINTENANCE OF THE TANKS

Regularly check the O rings of the fillers for good condition (to prevent water from entering the tanks).

Do not turn off the fuel taps after each use (except in case the boat is unattended for long).

Keep the fuel tanks as full as possible (to avoid condensation).

Every year check the fuel system for condition (hose, valves, etc.).

Ask a professional to carry out the works on the damaged parts of the fuel system.

Please note: the capacity of the tanks (that is indicated in the page 'SPECIFICATIONS') may be not completely useable according to the trim and load of the boat.

Always keep 20% fuel as a reserve.

- FUEL FILTERS

In order to prevent any water infiltration, the fuel runs through two filters: the first one is on the pipe that links the tank to the engine (designed as a water decanter and pre-filter), the second one is an integral part of the engine (designed to filter fuel finely). To know when you have to intervene and how frequently you have to change them, please refer to the engine instruction guide.

Drain it by undoing the knurled screw on the base of the decantation bowl (but do not remove it).

Allow to flow into a box till the fuel looks clean.

Do it several times a year.

Change the pre-filter at least once a year (access to it when you remove the bowl).



DASH BOARD

DASH BOARD



MOTORIZATION

88

LAGOON 450

■ 8.3 Propellers - Anodes

- PROPELLERS

The propellers supplied with your boat are the result of tests carried out jointly with the engine manufacturer.

Do not change them without consulting a specialist.

- FOLDING PROPELLERS (OPTIONAL EXTRA)

Remove the folding propellers at the end of each season, dismantle them and clean them carefully.

Grease the thrust bearing surfaces and teeth.

Check that the blades move easily.

- ANODES

Regularly check the sacrificial anodes corrosion.

The wear of the anodes depends on numerous factors and their lives may highly vary. Change them whenever necessary.

Never paint an anode.

Ask a professional to check and maintain the whole propulsion system.

■ 8.4 Dash board

On the dash board you can find all the functions to monitor the engine.

Please refer to the engine instruction guide supplied with the boat; it gives you explanations about the indicator lights, dials and warning lights on the dash board.

■ 8.5 Optional controls

The boat may optionally be fitted with an extra engine control and with joystick in the saloon.

Please refer to the appropriate user's manual regarding the engines (with double control) and how to use them (joystick).



WINTER STORAGE

9

- 9.1 Laying up**
- 9.2 Protection**

PACKING

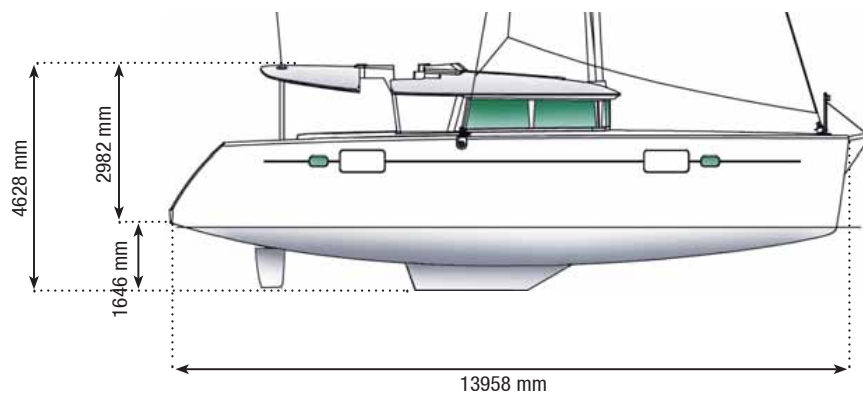

WINTER STORAGE

92

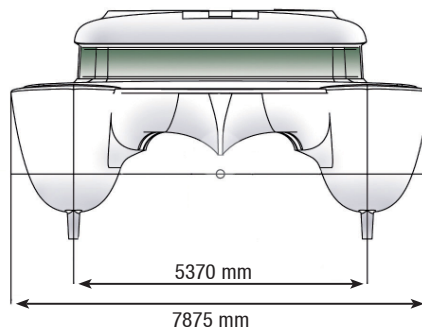

LAGOON 450

■ 9.1 Laying up

- Take ashore all the ship's log, the ropes that are not used for mooring her, the galley equipment, supplies, clothes, the safety equipment.
- Check the expiry dates of the safety equipment.
- Have the liferaft overhauled.

Take advantage of this laying up to draw up a complete inventory of the equipment.

■ 9.2 Protection

• WATER SYSTEM

- Drain the fresh water system.

Let water run from the taps until the system runs dry.

Check that there is no water left in the pipes and hoses (possible low points).

- Take off the filters, remove the water.

Clean the filters if necessary then put them back.

- Drain the water heater.

Check that there is no water left.

Close the drain.

- Lubricate all the water inlet valves and sea cock fittings.
- Rinse and completely drain the toilets bowls.

• INSIDE

- Seal air inlets as much as you can.
- Install an air dehumidifier in the saloon and leave the cabin and storage unit doors open (stowage cupboards, icebox).

- Leave the cushions outside for long before putting them back into the boat in the upright and side position in order to have minimum contact surfaces.

- Drain and clean the bilges.

- Possibly place the floorboards in a vertical position to make possible the ventilation of the different compartments.

- Open the refrigerators / conservator doors.

• OUTSIDE

- Carefully drain the cockpit shower.

- Thoroughly rinse the hull and deck.

- Lubricate all the mechanical and mobile parts with vaseline (bolts, hinges, locks, etc.).

- Protect all ropes and mooring lines against chafing.

- Protect the boat to the highest degree with fenders.

- Make sure the boat is properly moored.

• ENGINES

The engines winterizing has to be prepared by a specialist.

The preparation for winterizing is different according to the place where the boat will be stored - either in the water or on the shore.

RECOMMENDATION

All these recommendations do not make up an exhaustive list. Your dealer will give you the advice you need and will carry out the technical maintenance of your boat.



HANDLING

10

10.1 Preparation

10.2 Crane lifting

10.3 Mast stepping and removal

CRANE LIFTING INSTRUCTIONS

HANDLING

96

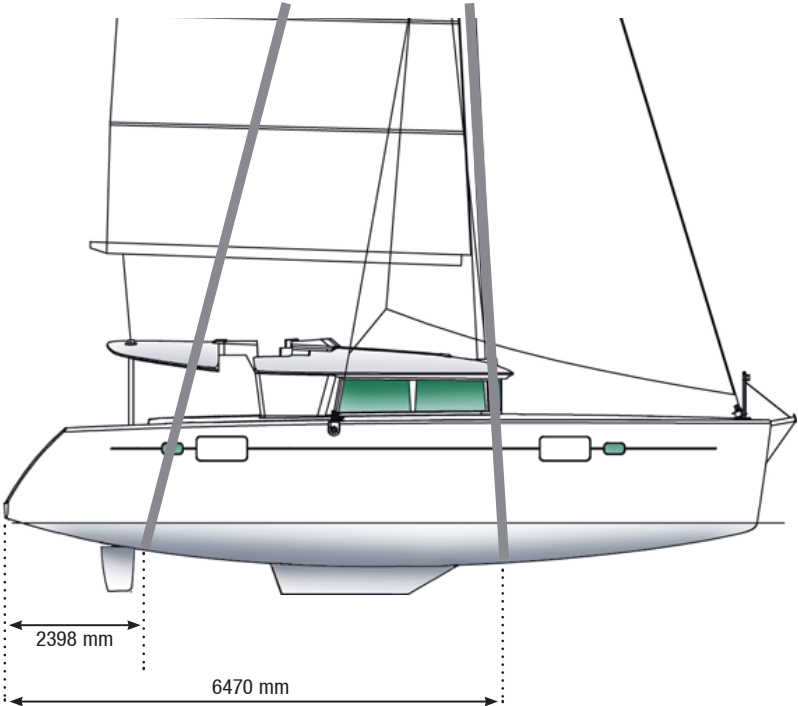

LAGOON 450

■ 10.1 Preparation

The initial launching and the first tests of the different equipments shall be carried out by your dealer so that you can expect to enjoy the warranty in case of some equipment failure.

All further handling shall be carried out with the highest care by professionals.

If the LAGOON boatyard are not involved in your handling operations, they cannot cover under guarantee any possible accidents linked to handling.

If later you have to launch your boat yourself, you should take the following precautions:

- Retract the sensors under the hull into their housings (they may be damaged by the handling slings).
- Check the water suction boxes for cleanliness.
- Turn off all the water inlet and drain valves (grey waters, black waters, engine).
- Check the anodes are in good condition and properly installed. An anode shall never be painted.

■ 10.2 Crane lifting

- Install a bow mooring rope, a stern mooring rope and fenders.
When using a crane to move the boat, check that slings cannot touch any device (depth finder, speedometer, etc.) nor the propellers.

The crane hook will be fitted with a gantry or a spreader system with two slings.

The slings shall not be connected directly onto the hook, as it would result in unusual compressive stresses on the hull.

- Crane lifting should be carried out slowly.
- Control the movement of the boat using mooring ropes.

DANGER
Do not stay on board or under the boat during craning.

■ 10.3 Mast stepping and removal

Mast stepping and removal shall be carried out by a professional.

10

SAFETY

11

- 11.1 Prevention**
- 11.2 Gas system**
- 11.3 Fire**
- 11.4 Bilge pump system**
- 11.5 Safety equipments**
- 11.6 General remarks**

SAFETY

100

LAGOON 450

■ 11.1 Prevention

- THE CREW

For your own safety and your crew's, you shall respect some basic principles:

- Before you sail, check the different components of your safety equipment, their location and their expiry dates.
- Check the location and validity of the official documents as well.
- Tell the crew where the safety equipment is, how it works and the elementary safety procedures to follow.

When sailing, always be able to indicate your precise position. In case an incident on board should happen and help be asked, this will be the very first question you will be asked.

RECOMMENDATION

Equip the children (and depending on the weather, the whole crew as well) with life jackets or harnesses.

WARNING

Do not exceed the number of persons indicated in Chapter 'SPECIFICATIONS'. If you do not take the number of persons into account, the combined weight of the persons and equipment should never exceed the maximum load recommended by the builder.

- THE BOAT

For the sake of prevention and to be able to feel confident to face successfully the possible dangers on board (fire, leak), learn to recognize and locate the different elements which might be the cause of these disorders and the equipments to cope with them as well.

Risk of fire:

- Electrical system (chapter 7)
- Engines (chapter 8)
- Gas system (chapter 11)

Risk of leak:

- Water systems (chapter 6)

RECOMMENDATION

In emergency situation, it is essential to be able to locate quickly all the appropriate safety equipments.

GAS SYSTEM

SAFETY

102



*Nota: the same layout can be observed
in the other version.*

- 1 - Gas valves.
- 2A - Locker / storage space of gas bottles.
- 2B - Electrovalve (U.S. version).

GAS VALVES



LOCKER / STORAGE SPACE FOR GAS BOTTLES



LAGOON 450

■ 11.2 Gas system

The port side front cockpit locker has been designed to store two gas cartridges.

The circuits opening / closing valves are located in the cupboard under the oven unit.

The boat in her U.S. version has an electrovalve located in the locker where the bottles are stored.

Turn on the electronically controlled valve using the related circuit breaker on the electrical panel.

RECOMMENDATION

Close the gas valve and turn off the regulator tap when the stove and oven are not used.

• SAFETY INSTRUCTIONS

A gas-powered appliance uses the oxygen and releases combustion products. Ventilate your boat when you use this appliance.

Regularly check and replace the rubber tubings that link the bottle to one end of the circuit and the stove to the other one, depending on the standards and regulations in force in your country.

Close the valves before you change bottles and immediately in case of emergency.

In case you smell gas or find that the burners have gone out, turn off the valve of the appliance. Do ventilate the boat in order to get rid of any residual gas. Find the cause of the problem.

Use only the compartment the gas bottles are allotted to store them

■ 11.3 Fire

The boat is delivered with no extinguisher.

Be sure:

- To fit the boat with extinguishers in pursuance of the regulations of the country where your boat is registered.
- To have the extinguishers checked in accordance with the instructions given.
- To refill or replace the extinguishers by similar equipment if the extinguishers have been used or are out of date.
- Make sure the extinguishers are accessible when people are on board.

Tell the crew:

- where the extinguishers are and how they work.
- where the extinguisher hole in the engine bay is (under the aft cabins berths, both on the port and starboard sides).
- where the emergency exits are.

INSIDE SAFETY EQUIPMENTS



- 1 - Emergency exit.
- 2 - Extinguisher vent.
- 3 - Fire extinguisher.
- 4 - Distress flares.
- 5 - First aid kit.
- 6 - VHF (optional extra).
- 7 -
- 8 -
- 9 -
- 10 -
- 11 -
- 12 -
- 13 -
- 14 -
- 15 -

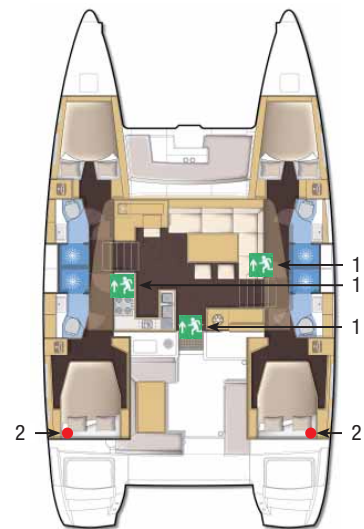

EXTINGUISHER VENT



RECOMMENDATION
Some elements do not have a pre-determined location for them.
Fill-in this drawing according to your own safety equipments.

SAFETY

• ESSENTIAL PRUDENCE RULES

Never:

- Obstruct access to the emergency exits.
- Obstruct safety controls (fuel valves, gas valves, power switches).
- Obstruct the access to the extinguishers placed in cupboards or lockers.
- Leave the boat unattended when a stove or heater is in use.
- Use gas lamps in the boat.
- Alter any of the boat's systems (electricity, gas or fuel).
- Fill up a tank when an engine is running or a stove or heater is on.
- Smoke while handling fuels.

Make sure that engine bays are clean at all times and regularly check that there are no fumes or fuel and gas leaks.

Do not store flammables products in the engine holds.

WARNING

Should you replace components of the fire extinction system, only proper components with the same designation or with equivalent technical capacities and fire resistance should be used.

DANGER

Use CO2 extinguishers only to fight electrical fires. Evacuate the area immediately after discharging the product to prevent asphyxia. Ventilate before entering.

• PROCEDURE TO FOLLOW IN THE EVENT OF FIRE

- Turn off the engines if operating.
- Cut off the power supply, the fuel supply.
- Cut off all sources of air (smother the fire using blankets).
- Hold the extinguisher upright and aim at the heart of the fire.

If fire broke out in an engine hold:

- Turn off the engines if operating.
- Cut off the power supply, the fuel supply.
- Shut off the air supply using towels to block off the engine air inlets, intakes and outlets.
- Cast the extinguisher product using the extinguisher vent located at the back of the aft cabins berths.
- Make sure that the fire is completely under control.
- Open the bay access hatch to make any necessary repair.

11

SAFETY

105

OUTSIDE SAFETY EQUIPMENTS

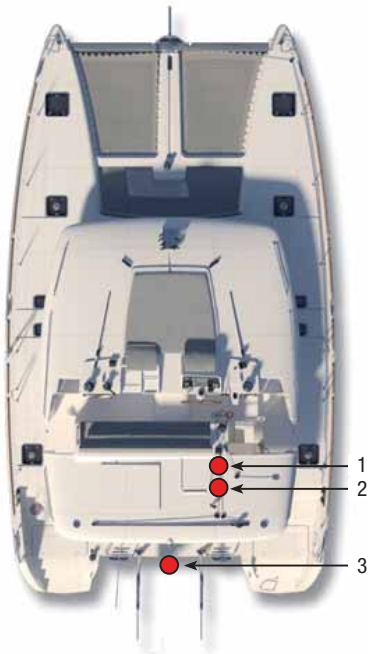

- 1 - Manual bilge pumps.
- 2 - Cranks location.
- 3 - Location of the life raft.
- 4 - Extinguishers.
- 5 - Life buoy location.
- 6 -
- 7 -
- 8 -
- 9 -
- 10 -
- 11 -
- 12 -
- 13 -
- 14 -
- 15 -

RECOMMENDATION
Some elements do not have a pre-determined location for them.
Fill-in this drawing according to your own safety equipments.

LIFE RAFT



MANUAL BILGE PUMPS



CRANKS



■ 11.4 Bilge pump system

- BILGE PUMPS

The boat is fitted with three bilge pumps in each hull:

- an electric pump with manual release (located in the selector board in the cupboard at the starboard entrance of the saloon).
- an electric pump automatic release located in the well.
- a manual cockpit pump.

For further information, please refer to Chapter 'WATER SYSTEMS'.

- MANUAL BILGE PUMPS

In case of failure or if the electric bilge pumps are not enough, you can use the manual bilge pumps with cranks (located on the starboard side of the aft cockpit).

- PROCEDURE TO FOLLOW IN THE EVENT OF A LEAK

Make sure that the electric bilge pumps are switched on.

If it is not enough to overcome the water level, ask a crew man to use a manual pump.

■ 11.5 Safety equipments

Before you sail, list the compulsory safety equipments.

Do not exceed the number of persons indicated in Chapter 'SPECIFICATIONS'.

WARNING

The list of the compulsory safety equipments corresponds to a certification category, a design category as well as to the regulations in the country where the boat is registered.

- LIFE RAFT

The life raft is to be stored under the rear beam.

Fit your boat with a life raft in pursuance of the regulations of the country where the boat is registered.

You shall use the life raft only if all else fails.

RECOMMANDATION

Before you sail to sea, carefully read the launching instructions on the life raft.

EMERGENCY TILLER - MAN HOLES

SAFETY

108



- 1 - Man hole.
- 2 - Emergency tiller cover.

*Nota: the same layout can be observed
in the other version.*

EMERGENCY TILLER USE



EMMERGENCY HAMMER + MANHOLE HATCH



LAGOON 450

- **EMERGENCY TILLER**

The emergency tiller is stored in a locker.
It shall be kept easily accessible.

To operate the tiller:

- Use a winch handle and unscrew one of the tiller covers situated on one of the aft transom extensions.
- Insert the tiller into the rudder stock, making sure it is well fitted into the tiller head block.
- Unplug every device connected to the spindles of the rudders.

- **CAPSIZING**

Two "man holes" are provided in each hull passageways.

An emergency hammer located next to each hatch and at the bottom of the bib locker.

You can gain access to the life raft under the rear beam.

WARNING

Regularly check the safety equipments are in good working order.

Follow the service programme without fail.

Generally speaking, take particular care of all the safety equipment of your boat.

■ 11.6 General remarks

- **MANOEUVRES**

- Know where your crew members are and inform them before you manoeuvre on the boat.
- Carefully manoeuvre on the deck and always wear shoes.

- **ENGINES**

- Systematically stop the engines before you dive or swim next to the boat.
- Never try to free a fishing net or a piece of rope that is caught on a propeller when the latter is rotating.

- **TOWING**

If you have to tow another boat, tow her at a reduced speed and as smoothly as you can.

Be particularly careful when throwing or catching the towing line (it may catch on the propellers).

MAINTENANCE

12

12.1 Maintenance schedule

12

■ 12.1 Maintenance schedule

The information given hereafter are only examples and it is not an exhaustive list.

They must be adapted, depending on the use of your boat.

WARNING

Follow without fail the recommendations given in the instruction guides by the manufacturers of the components added to your boat.

HULL / DECK FITTING / HULL

Clean the hull with appropriate products QUATERLY
 Clean s/s parts..... QUATERLY
 Dismount, clean and grease winches ANNUAL
 Check the watertightness of the sea-cock fittings..... BI-ANNUAL
 Clean the sea cock fittings and strainers from the outside BI-ANNUAL

MOORING / WINDLASS

Rinse ground tackle and anchor locker with fresh water..... WHEN USED
 Check the gypsy and anchor/chain fastening device BI-ANNUAL
 Check windlass brake system QUATERLY
 Check mooring lines and fenders..... BI- ANNUAL
 Check the electric connections (remote control, relay, etc.) QUATERLY

RUNNING / STANDING RIGGING / SAILS

Lubricate the different travellers with teflon QUATERLY
 Check and tighten the different shackles QUATERLY
 Check the running rigging tightening QUATERLY
 Check the halyard and sheet for wear points QUATERLY
 Rinse the whole running rigging and sails QUATERLY
 Check the mainsail battens and main seams QUATERLY

UPHOLSTERY AND COVERS

Rinse / clean the different covers QUATERLY
 Dry the outside upholstery before its storage WHEN USED

MAINTENANCE

REFRIGERATION UNIT

Defrost the refrigerators and conservator QUATERLY
Check the door joints QUATERLY

AIR CONDITIONING

Check the sea cock and clean / change the different
sea water filters QUATERLY
Dust off the unit heater fansANNUAL

ELECTRICITY

Check and tighten the battery terminal connections
and main switch connections.....BI-ANNUAL
Check and tighten the main relay terminals
(winches, windlass, etc.)BI-ANNUAL

ENGINES AND GENERATOR

Check oil level QUATERLY
Check belt tension QUATERLY
Clean the sea water strainer QUATERLY
Check for leaks (oil, water, fuel) and smokes QUATERLY
Check and drain the decanter filters (fuel)QUATERLY
General overhaul REFER TO THE ENGINE MANUFACTURER'S GUIDE

WATERMAKER

Check and clean the sea water suction strainersQUATERLY
General inspection by the manufacturerANNUAL

PLUMBING

Check the automatic bilge pumps and alarmsQUATERLY
Rinse the black water tanks QUATERLY
Check the manual bilge pumps..... QUATERLY
Check the pressure water pump..... QUATERLY
Check the different drains and scuppers QUATERLY
Open and close the different valves on board
+ grease if necessary BI-ANNUAL

12

MAINTENANCE

PERSONAL NOTES

.....
.....
.....
.....
.....
.....
.....
.....
.....
.....
.....
.....
.....
.....
.....
.....
.....
.....
.....
.....



This document is not contractually binding. Descriptions, illustrations, etc are provided only for your guidance. Our models may undergo some standard modifications or improvements without notice.

